

300mA Low Dropout Linear Regulator of Fixed 2.85V, 3.3V and 3.5V

Features

- Low Dropout Voltage of 1.2V at 300mA
- Output Voltage Accuracy $\pm 2.0\%$
- Line Regulation - 1mV (typ.)
- Load Regulation - 6mV (typ.)
- Input Voltage Range up to 9V
- Internal Current Limiting and Thermal Shutdown Protections
- Available Output Voltages - 2.85V, 3.3V and 3.5V
- Various SOT-89 and TO-92 Packages Available

Applications

- Voltage Regulator for CD-ROM Drivers
- Voltage Regulator for LAN Cards
- Wireless Communication Systems
- Portable Instrument
- Portable Consumer Equipment
- Low Voltage Systems

General Description

The APL5833 is a 3-pin low dropout linear regulator with 2.0% accuracy of output voltage over line, load and temperature variations. Dropout voltage at 300mA output current is less than 1.2V. Both output current limiting and thermal shutdown are built in to provide maximal protection to the APL5833 against fault conditions. The over current and thermal shutdown circuits become active when the current exceed 300mA, or the junction temperature reach 150°C. Normal operation is recovered when junction temperature drops below 130°C.

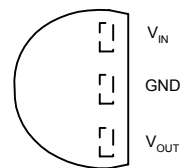

TO-92 (Top View)

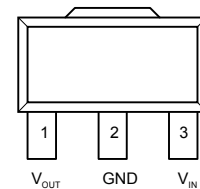

SOT-89 (Top View)

Ordering/ Marking Information

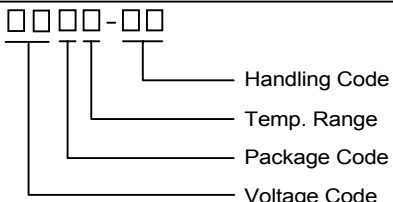
<p>APL5833 □□□□-□□</p>  <p>Handling Code</p> <p>Temp. Range</p> <p>Package Code</p> <p>Voltage Code</p>	<p>Package Code D : SOT-89 E : TO-92</p> <p>Temp. Range C : 0 to 70 °C</p> <p>Handling Code TB : Tape & Box TR : Tape & Reel PB : Plastic Bag</p> <p>Voltage Code : 28 : 2.85V 33 : 3.3V 35 : 3.5V</p>
---	--

ANPEC reserves the right to make changes to improve reliability or manufacturability without notice, and advise customers to obtain the latest version of relevant information to verify before placing orders.

APL5833 - 28 : APL5833 XXXXX28	XXXXX - Date Code	APL5833 - 33 : APL5833 XXXXX33	XXXXX - Date Code
APL5833 - 35 : APL5833 XXXXX35	XXXXX - Date Code		

Block Diagram

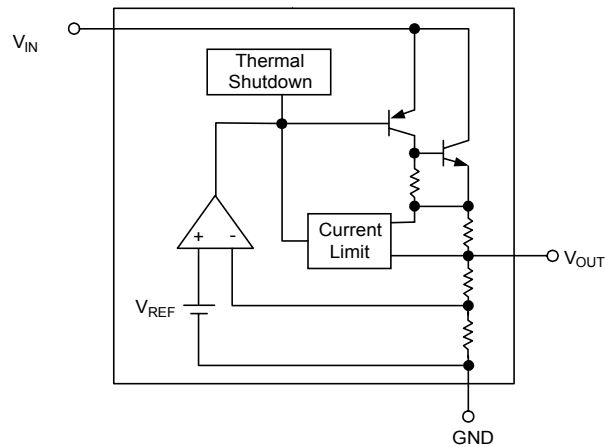

Absolute Maximum Ratings

Symbol	Parameter		Rating	Unit
V_{IN}	Input Voltage		9	V
I_{OUT}	Output Current		300	mA
T_A	Operating Ambient Temperature Range		0 to 70	°C
T_J	Operating Junction Temperature Range		-40 to +150	°C
T_{STG}	Storage Temperature Range		-65 to +150	°C
P_D	Power Dissipation Package	SOT-89	550	mW
		TO-92	550	
θ_{JA}	Thermal Resistance	SOT-89	180	°C / W
		TO-92	180	

Electrical Characteristics ($T_A=25^\circ\text{C}$, unless otherwise noted)

Symbol	Parameter	Test Conditions	APL5833			Unit
			Min.	Typ.	Max.	
V_{IN}	Input Voltage		$V_{OUT}+1.2\text{V}$		9	V
V_{OUT}	Output Voltage	$I_{OUT}=10\text{mA}$	$0.98 V_{OUT}$		$1.02 V_{OUT}$	V
I_{OUT}	Output Current Capability	$V_{OUT}=3.3\text{V}, \Delta V_{OUT}=2\%$	300			mA
I_{SC}	Short Circuit Current	$V_{OUT} < 0.4\text{V}$		500		mA

Electrical Characteristics Cont.

Symbol	Parameter	Test Conditions	APL5833			Unit
			Min.	Typ.	Max.	
I_Q	Quiescent Current	$V_{IN}=5V$, No Load		6	10	mA
REG_{LINE}	Line Regulation	$I_{OUT}=10mA$, $V_{IN}= 5V$ to $8V$		1	6	mV
REG_{LOAD}	Load Regulation	$I_{OUT}=1mA\sim 300mA$		6	12	mV
$V_{DROPOUT}$	Dropout Voltage	$I_{OUT}=300mA$, $\Delta V_{OUT}=1\%$		1200	1300	mV
PSRR	Power Supply Rejection Ratio	at 1kHz		55		dB
OTS	Over Temperature Shutdown			150		$^{\circ}C$
E_N	Output Noise			100		μV_{rms}
TC	Output Voltage Temperature Coefficient			100		ppm/ $^{\circ}C$

Application Schematic

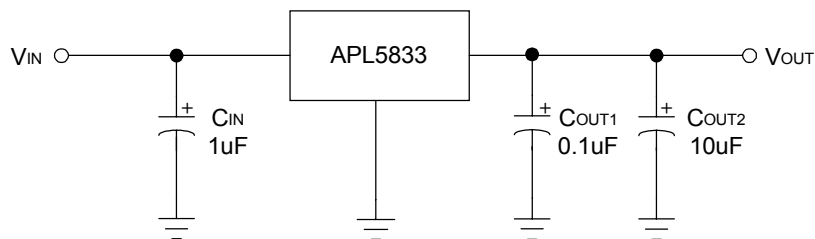

Typical Characteristics

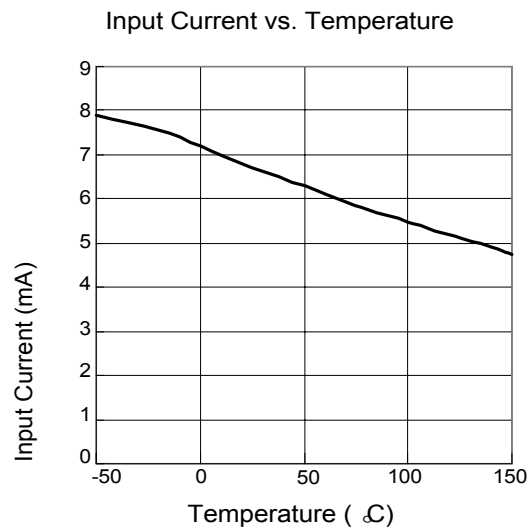
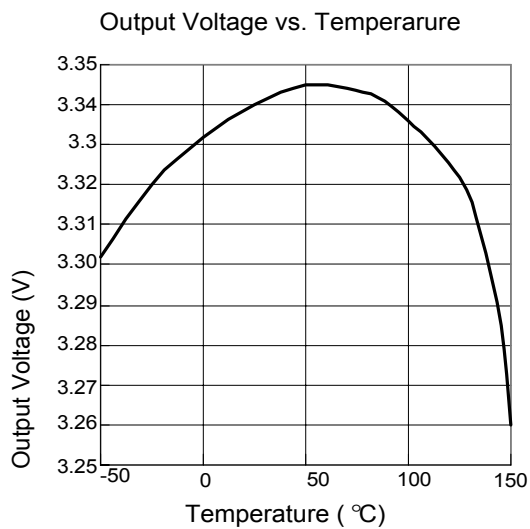

Typical Characteristics

Line Transient Response

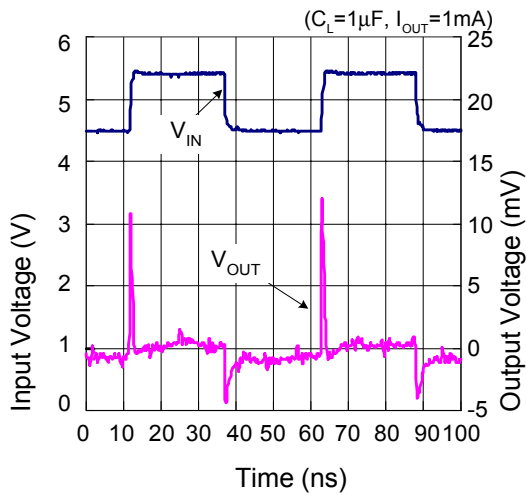

Line Transient Response

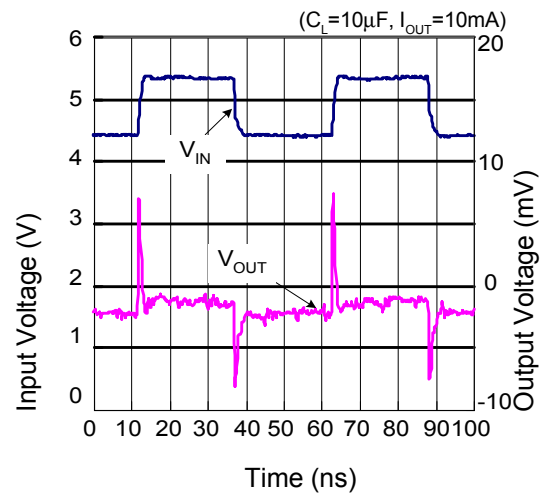

Load Transient Response

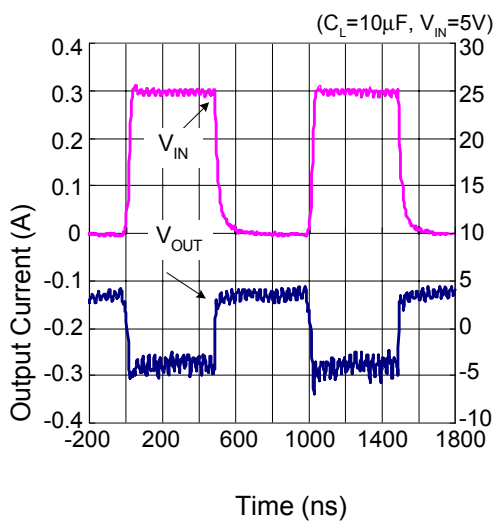

Output Voltage vs. Input Voltage

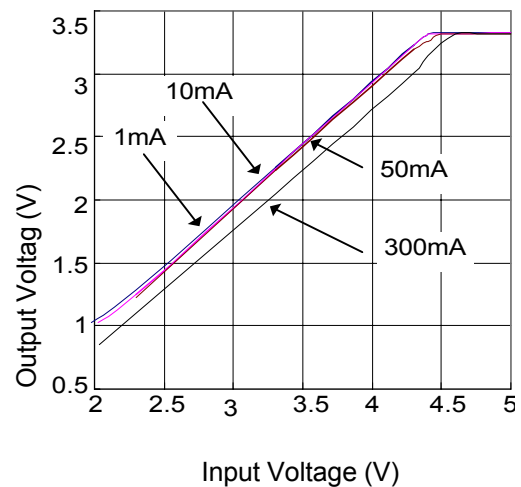

Typical Characteristics (Cont.)

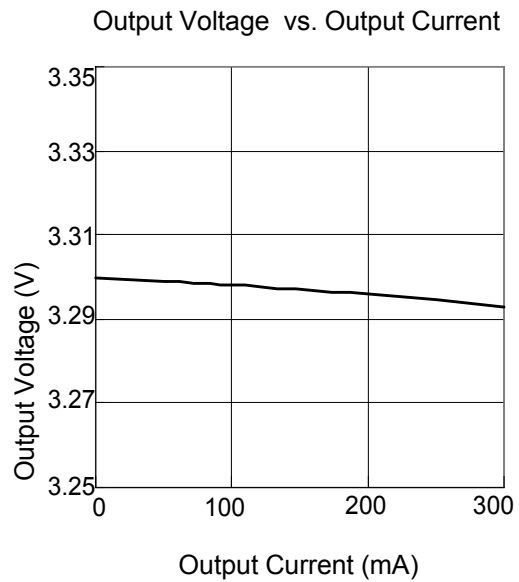
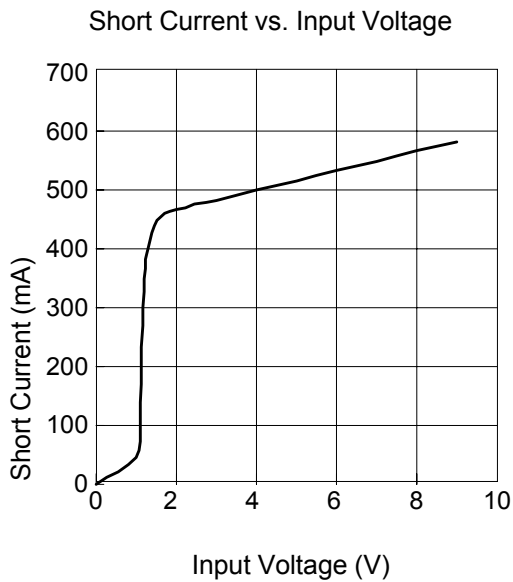
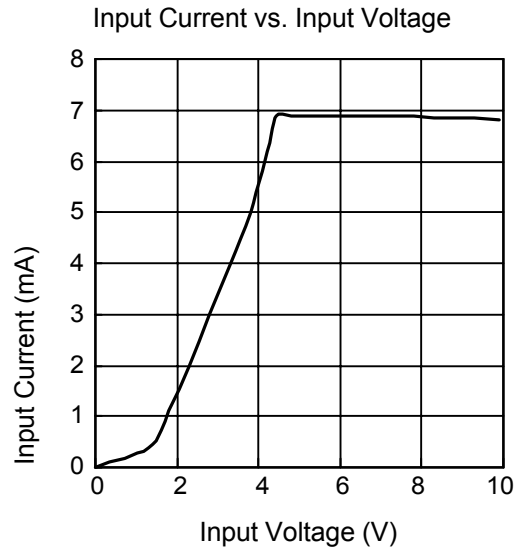
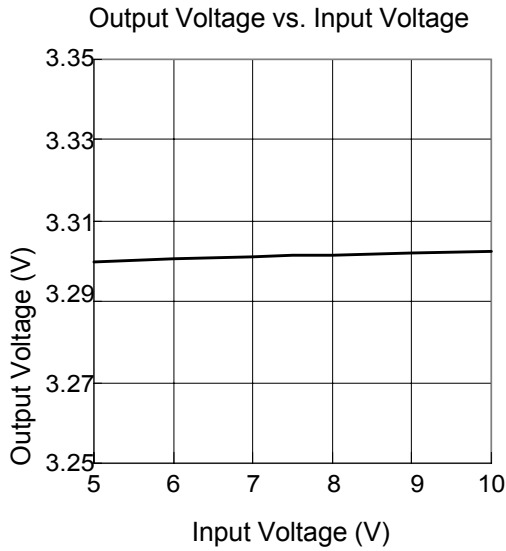

Typical Characteristics (Cont.)

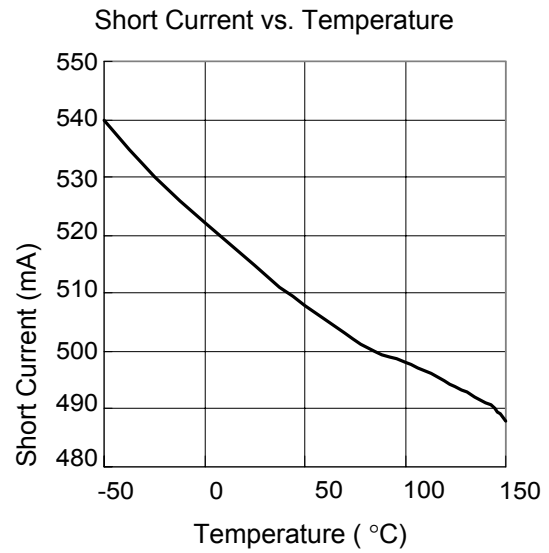
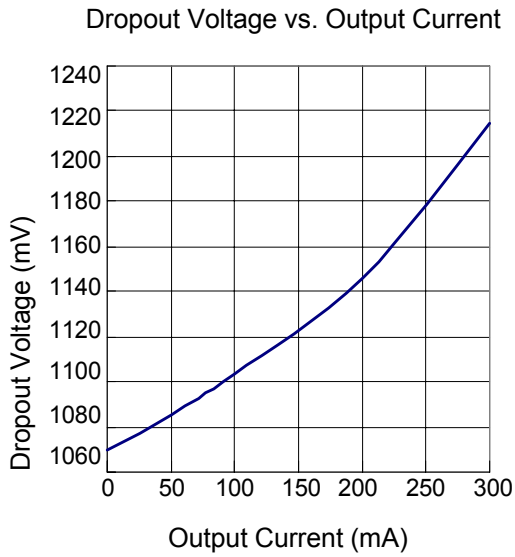

Packaging Information

TO-92 (Reference JEDEC Registration TO-92)

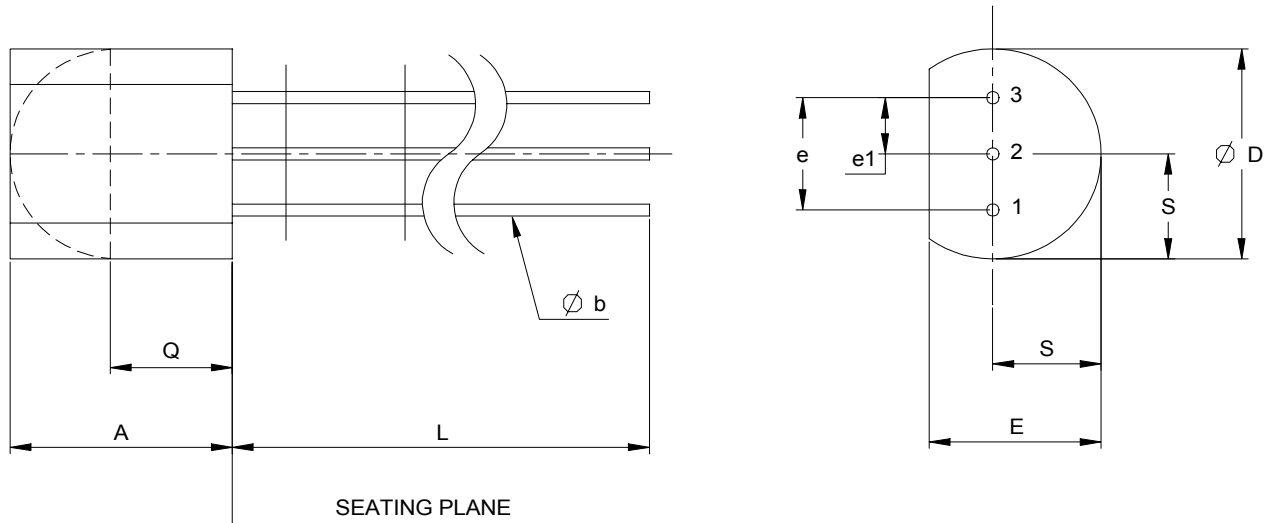

Dim	Millimeters		Inches	
	Min.	Max.	Min.	Max.
A	4.318	5.33	0.170	0.210
ϕb	0.356	0.53	0.014	0.021
ϕD	4.45	5.21	0.175	0.205
E	3.175	4.19	0.125	0.165
e	2.41	2.67	0.095	0.105
e1	1.14	1.40	0.045	0.055
L	12.70		0.500	
Q	1.27		0.050	
S	2.03	2.66	0.080	0.105

Packaging Information

SOT-89 (Reference EIAJ ED-7500A Registration SC-62)

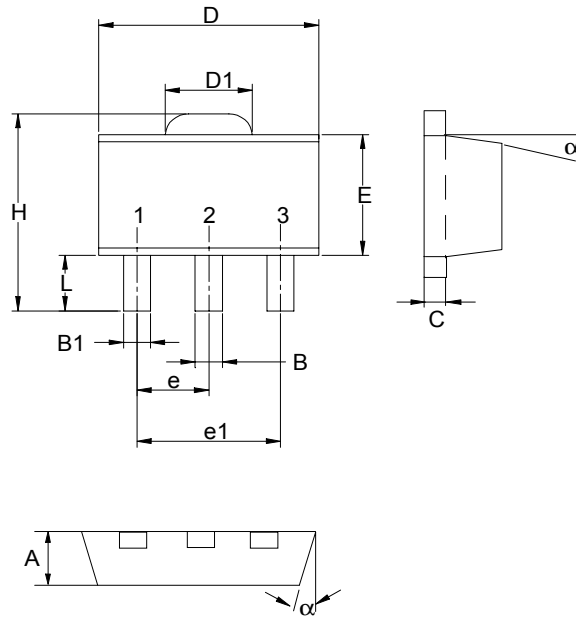

Dim	Millimeters		Inches	
	Min.	Max.	Min.	Max.
A	1.40	1.60	0.055	0.063
B	0.40	0.56	0.016	0.022
B1	0.35	0.48	0.014	0.019
C	0.35	0.44	0.014	0.017
D	4.40	4.60	0.173	0.181
D1	1.35	1.83	0.053	0.072
e	1.50 BSC		0.059 BSC	
e1	3.00 BSC		0.118 BSC	
E	2.29	2.60	0.090	0.102
H	3.75	4.25	0.148	0.167
L	0.80	1.20	0.031	0.047
α		10°		10°

Reliability test program

Test item	Method	Description
SOLDERABILITY	MIL-STD-883D-2003	245°C , 5 SEC
HOLT	MIL-STD-883D-1005.7	1000 Hrs Bias @ 125 °C
PCT	JESD-22-B, A102	168 Hrs, 100 % RH , 121°C
TST	MIL-STD-883D-1011.9	-65°C ~ 150°C, 200 Cycles
ESD	MIL-STD-883D-3015.7	VHBM > 2KV, VMM > 200V
Latch-Up	JESD 78	10ms , I _{tr} > 100mA

Carrier Tape & Reel Dimensions

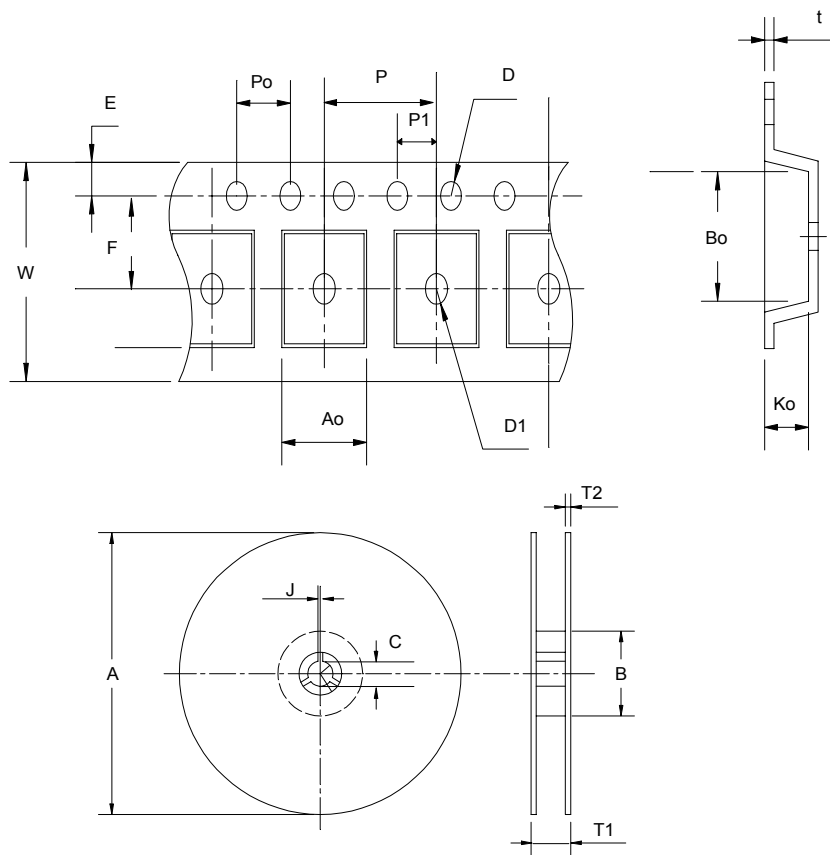

Application	A	B	C	J	T1	T2	W	P	E
SOT-89	178 ±1	70 ±2	13.5 ±0.15	3 ±0.15	14 ±2	1.3 ±0.3	12 + 0.3 12 - 0.1	8 ±0.1	1.75±0.1
Application	F	D	D1	Po	P1	Ao	Bo	Ko	t
SOT-89	5.5 ± 0.05	1.5± 0.1	1.5± 0.1	4.0 ± 0.1	2.0 ± 0.1	4.8 ± 0.1	4.5± 0.1	1.80± 0.1	0.3±0.013

(mm)

Physical Specifications

Terminal Material	Solder-Plated Copper (Solder Material : 90/10 or 63/37 SnPb)
Lead Solderability	Meets EIA Specification RS186-91, ANSI/J-STD-002 Category 3.
Packaging	1000 devices per reel

Reflow Condition (IR/ Convection or VPR Reflow)

Reference JEDEC Standard J-STD-020A APRIL 1999

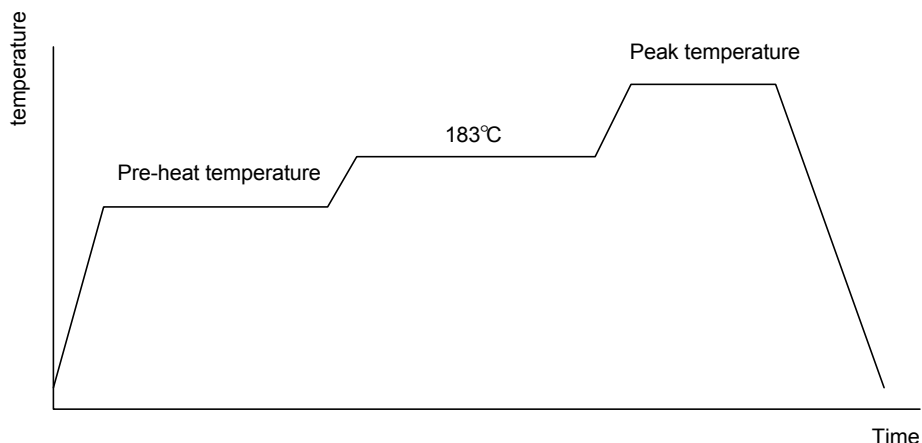

Classification Reflow Profiles

	Convection or IR/ Convection	VPR
Average ramp-up rate(183°C to Peak)	3°C/second max.	10 °C /second max.
Preheat temperature 125 ± 25°C)	120 seconds max.	
Temperature maintained above 183°C	60 ~ 150 seconds	
Time within 5°C of actual peak temperature	10 ~ 20 seconds	60 seconds
Peak temperature range	220 +5/-0°C or 235 +5/-0°C	215~ 219°C or 235 +5/-0°C
Ramp-down rate	6 °C /second max.	10 °C /second max.
Time 25°C to peak temperature	6 minutes max.	

Package Reflow Conditions

pkg. thickness ≥ 2.5mm and all bags	pkg. thickness < 2.5mm and pkg. volume ≥ 350 mm ³	pkg. thickness < 2.5mm and pkg. volume < 350mm ³
Convection 220 +5/-0 °C		Convection 235 +5/-0 °C
VPR 215-219 °C		VPR 235 +5/-0 °C
IR/Convection 220 +5/-0 °C		IR/Convection 235 +5/-0 °C

Cover Tape Dimensions

Carrier Width	12
Cover Tape Width	9.3

(mm)

Customer Service

Anpec Electronics Corp.

Head Office :

5F, No. 2 Li-Hsin Road, SBIP,

Hsin-Chu, Taiwan, R.O.C.

Tel : 886-3-5642000

Fax : 886-3-5642050

Taipei Branch :

7F, No. 137, Lane 235, Pac Chiao Rd.,

Hsin Tien City, Taipei Hsien, Taiwan, R. O. C.

Tel : 886-2-89191368

Fax : 886-2-89191369