

500mA Low Dropout Linear Regulator of Adjustable and Fixed Voltages

Features

- **Low Dropout Voltage of 1.3V at 500mA**
- **Output Voltage Accuracy $\pm 2.0\%$**
- **Line Regulation - 3mV (typ.)**
- **Load Regulation - 13mV (typ.)**
- **Input Voltage Range up to 9V**
- **Internal Current-Limit and Thermal Shutdown Protections**
- **Available Output Voltages -ADJ, 1.8V, 2.5V, 3.3V**
- **Various SOT-89 Package Available**
- **Lead Free and Green Devices Available (RoHS Compliant)**

Pin Configuration

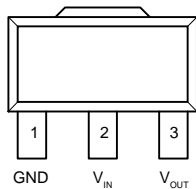

SOT-89 (Top View)

General Description

The APL5885 is a 3-pin low dropout linear regulator with 2.0% accuracy of output voltage over line, load and temperature variations. Dropout voltage at 500mA output current is less than 1.3V. Both output current limiting and thermal shutdown are built in to provide maximal protection to the APL5885 against fault conditions. The over current and thermal shutdown circuits become active when the current exceeds 500mA, or the junction temperature reaches 150°C. Normal operation is recovered when junction temperature drops below 130°C.

Applications

- **Voltage Regulator for CD-ROM Drivers**
- **Voltage Regulator for LAN Cards**
- **Wireless Communication Systems**
- **Portable Instrument**
- **Portable Consumer Equipment**
- **Low Voltage Systems**

Ordering and Marking Information

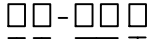
APL5885	 <p>Assembly Material Handling Code Temperature Range Package Code</p>	Package Code D : SOT-89 Operating Ambient Temperature Range C : 0 to 70 °C Handling Code TR : Tape & Reel Assembly Material G : Halogen and Lead Free Device	
APL5885 D :	<table border="1"> <tr> <td>APL5885 XXXXX</td> </tr> </table>	APL5885 XXXXX	XXXXX - Date Code
APL5885 XXXXX			
APL5885-18 D :	<table border="1"> <tr> <td>APL5885 XXXXX18</td> </tr> </table>	APL5885 XXXXX18	XXXXX - Date Code
APL5885 XXXXX18			
APL5885-25 D :	<table border="1"> <tr> <td>APL5885 XXXXX25</td> </tr> </table>	APL5885 XXXXX25	XXXXX - Date Code
APL5885 XXXXX25			
APL5885-33 D :	<table border="1"> <tr> <td>APL5885 XXXXX33</td> </tr> </table>	APL5885 XXXXX33	XXXXX - Date Code
APL5885 XXXXX33			

Note: ANPEC lead-free products contain molding compounds/die attach materials and 100% matte tin plate termination finish; which are fully compliant with RoHS. ANPEC lead-free products meet or exceed the lead-free requirements of IPC/JEDEC J-STD-020C for MSL classification at lead-free peak reflow temperature. ANPEC defines “Green” to mean lead-free (RoHS compliant) and halogen free (Br or Cl does not exceed 900ppm by weight in homogeneous material and total of Br and Cl does not exceed 1500ppm by weight).

Absolute Maximum Ratings (Note 1)

Symbol	Parameter	Rating	Unit
V _{IN}	Input Voltage	9	V
I _{OUT}	Output Current	500	mA
T _A	Operating Ambient Temperature Range	0 to 70	°C
T _J	Operating Ambient Temperature Range	-40 to +150	°C
T _{STG}	Storage Temperature Range	-65 to +150	°C
P _D	Power Dissipation Package	Interanl Limited	

Note 1: Absolute Maximum Ratings are those values beyond which the life of a device may be impaired. Exposure to absolute maximum rating conditions for extended periods may affect device reliability.

Thermal Characteristics (Note 2)

Symbol	Parameter	Typical Value	Unit
θ _{JA}	Thermal Resistance	180	°C / W

Note 2 : θ_{JA} is measured with the component mounted on a high effective thermal conductivity test board in free air.

Electrical Characteristics ($T_A=25^{\circ}\text{C}$, unless otherwise noted)

Symbol	Parameter	Test Conditions	APL5885			Unit
			Min.	Typ.	Max.	
V_{IN}	Input Voltage		$V_{OUT}+1.45V$	-	8	V
V_{OUT}	Output Voltage	$I_{OUT}=10\text{mA}$	$0.9 V_{OUT}$	-	$1.02 V_{OUT}$	V
I_{OUT}	Output Current Capability	$\Delta V_{OUT}=2\%$	500	-	-	mA
I_{SC}	Short Circuit Current	$V_{OUT}<0.4V$	-	800	-	mA
I_Q	Quiescent Current	$V_{IN}=5V, \text{No Load}$	-	6	10	mA
REG_{LINE}	Line Regulation APL5885 APL5885-18 APL5885-25 APL5885-33	$T_J=0\sim 125^{\circ}\text{C}$ $I_{OUT}=10\text{mA}, V_{OUT}+1.7V\leq V_{IN}\leq 8V$	-	3	6	mV
		$I_{OUT}=0A, 3.5V\leq V_{IN}\leq 8V$				
		$I_{OUT}=0A, 4.2V\leq V_{IN}\leq 8V$				
		$I_{OUT}=0A, 5V\leq V_{IN}\leq 8V$				
REG_{LOAD}	Load Regulation APL5885 APL5885-18 APL5885-25 APL5885-33	$T_J=0\sim 125^{\circ}\text{C}$ $(V_{IN}-V_{OUT})=1.7V, 0\leq I_{OUT}\leq 0.5A$	-	0.4	0.6	%
		$V_{IN}=3.5V, 0\leq I_{OUT}\leq 0.5A$				
		$V_{IN}=4.2V, 0\leq I_{OUT}\leq 0.5A$				
		$V_{IN}=5V, 0\leq I_{OUT}\leq 0.5A$				
$V_{DROPOUT}$	Dropout Voltage	$I_{OUT}=500\text{mA}, \Delta V_{OUT}=1\%$	-	1300	1450	mV
PSRR	Power Supply Rejection Ratio	at 1kHz	-	55	-	dB
OTS	Over Temperature Shutdown		-	150	-	$^{\circ}\text{C}$
E_N	Output Noise		-	100	-	μVrms
TC	Output Voltage Temperature Coefficient		-	100	-	ppm/ $^{\circ}\text{C}$

Typical Operating Characteristics

Output Voltage vs. Temperature

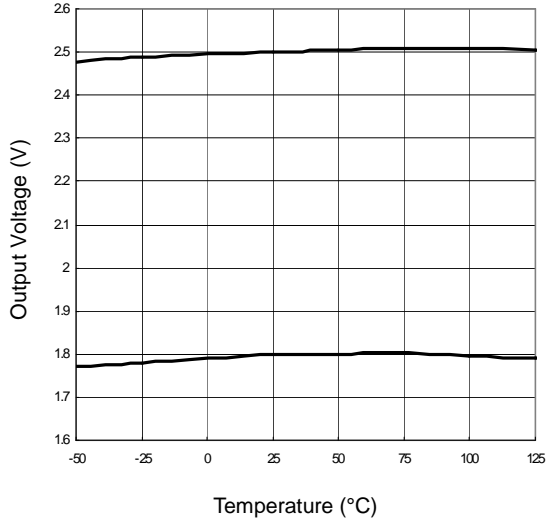

Output Voltage vs. Temperature

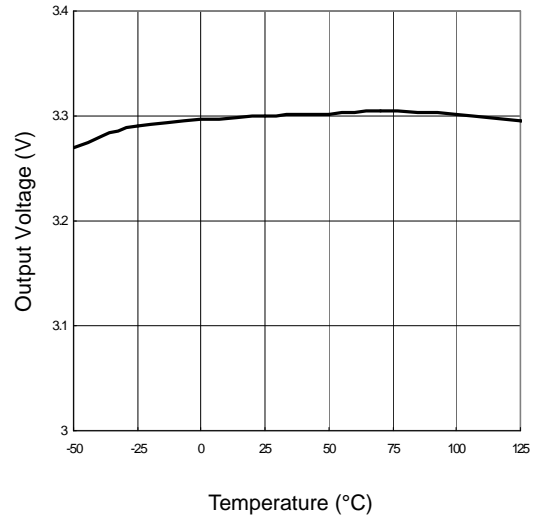

Line Transient Response

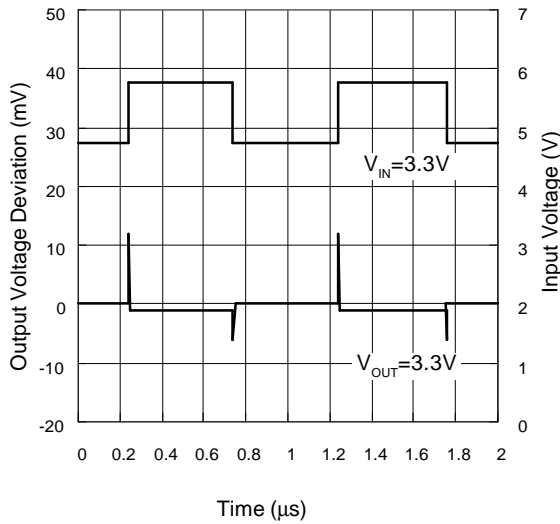

Load Transient Response

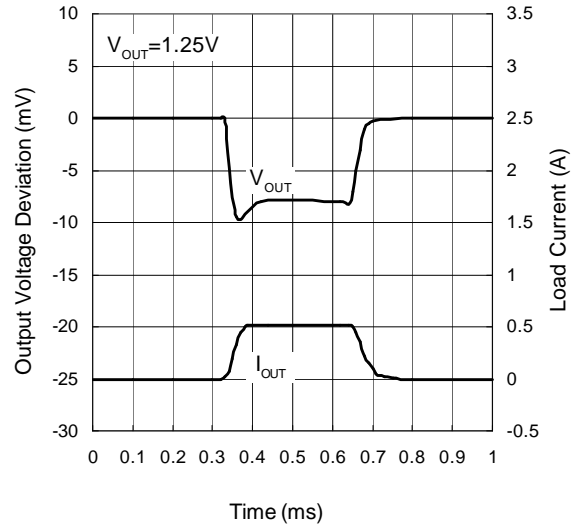

Typical Operating Characteristics (Cont.)

Adjust Pin Current vs. Temperature

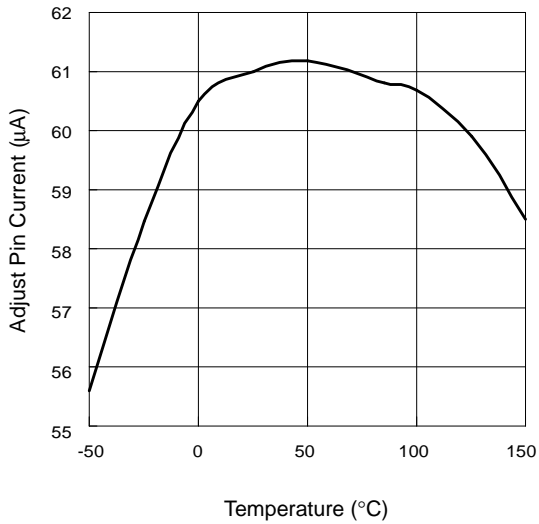

Output Voltage vs. Input Voltage

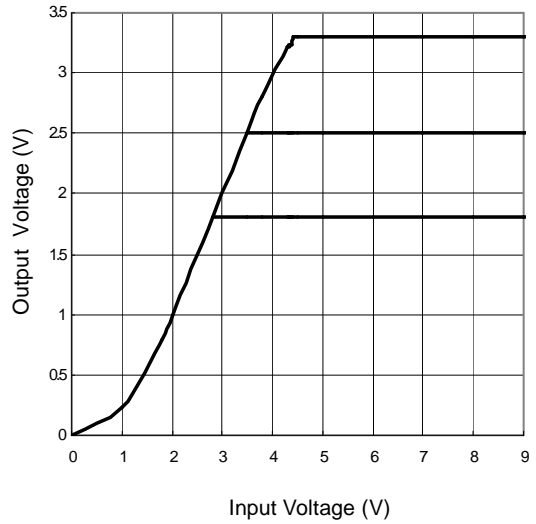

Short Circuit Current vs. Temperature

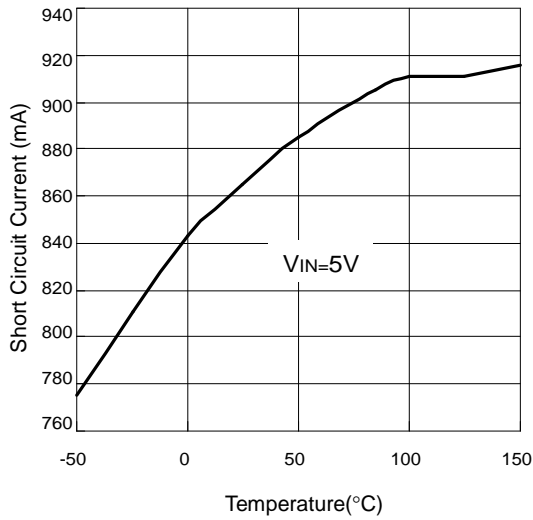

Load Regulation vs. Output Current

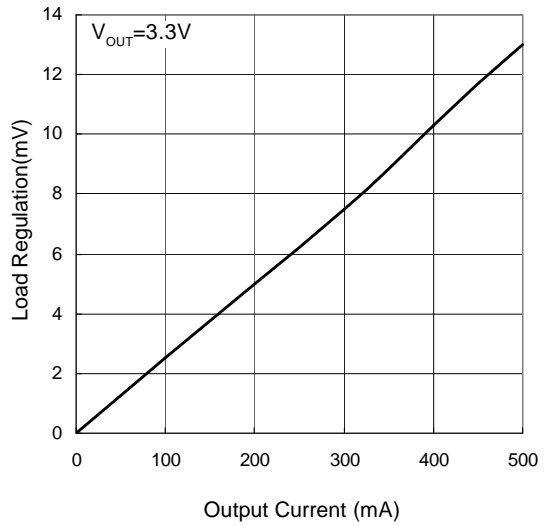

Typical Operating Characteristics (Cont.)

Short Circuit Current vs. Input Voltage

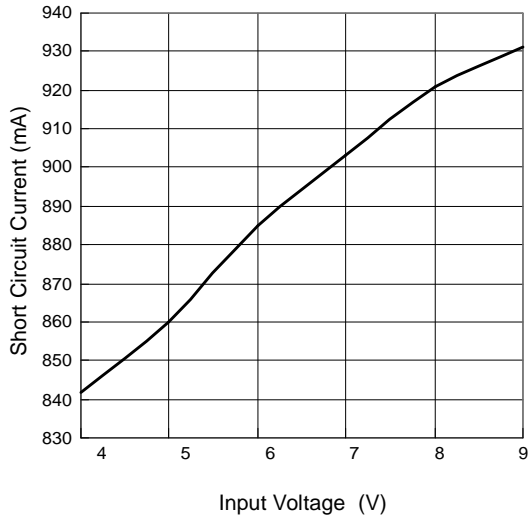

Output Current vs. Dropout Voltage

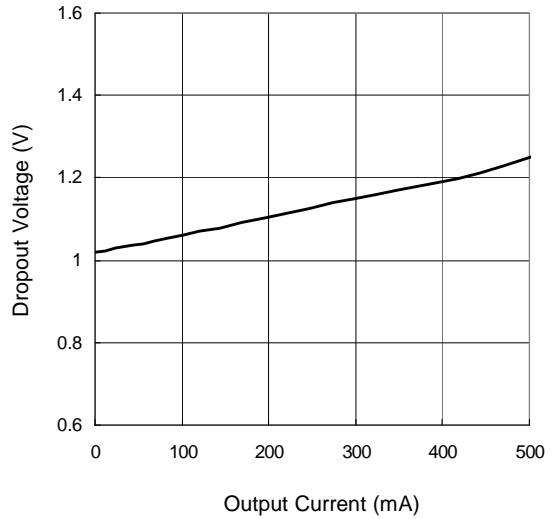

Quiescent Current vs. Temperature

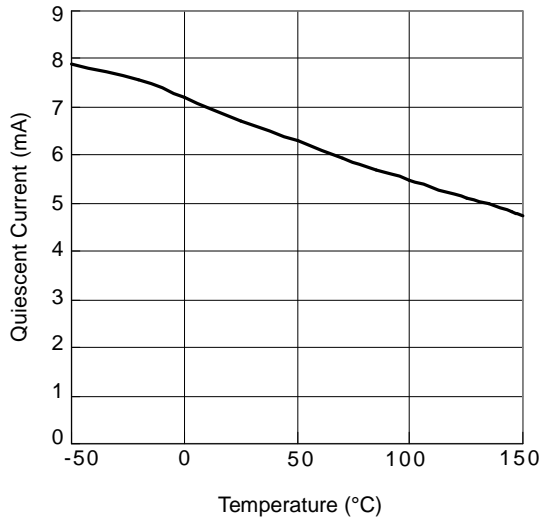

Input Current vs. Input Voltage

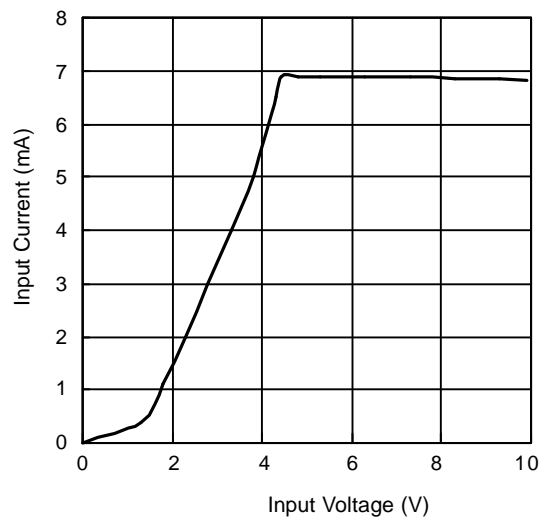

Block Diagram

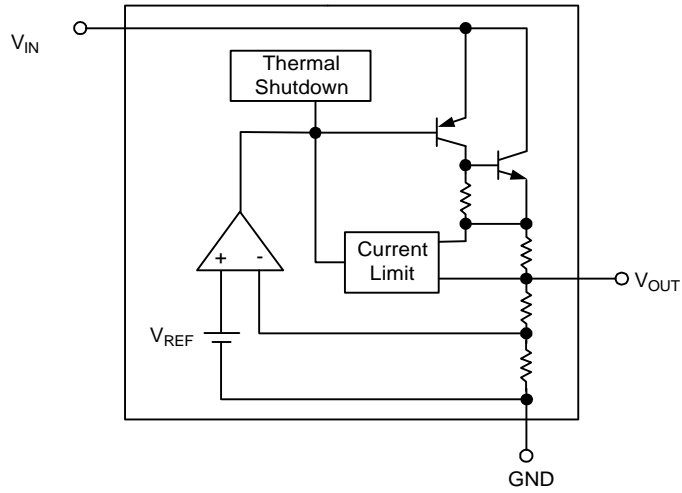

Typical Application Circuit

1.25V to 7V Adjustable Regulator

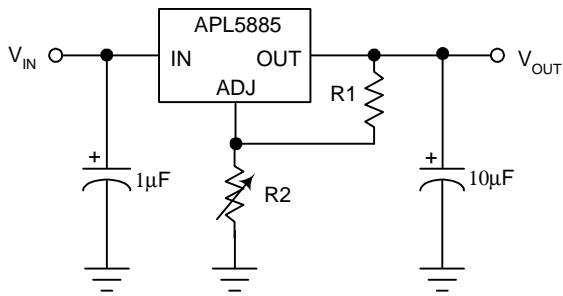

$$V_{OUT} = 1.250V \times \frac{R1 + R2}{R1}$$

Fixed 1.8V, 2.5V and 3.3V Regulator

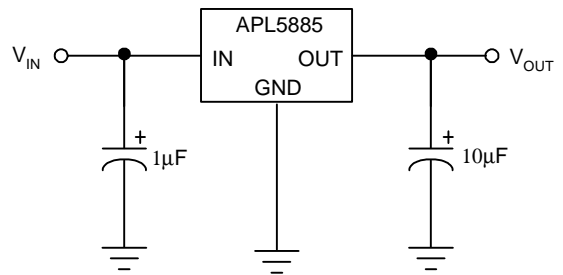

Package Information

SOT-89

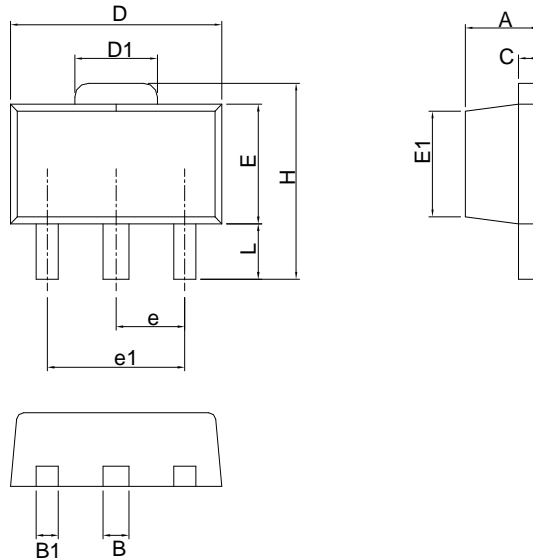

SYMBOL	SOT-89			
	MILLIMETERS		INCHES	
	MIN.	MAX.	MIN.	MAX.
A	1.40	1.60	0.055	0.063
B	0.44	0.56	0.017	0.022
B1	0.36	0.48	0.014	0.019
C	0.35	0.44	0.014	0.017
D	4.40	4.60	0.173	0.181
D1	1.62	1.83	0.064	0.072
E	2.29	2.60	0.090	0.102
E1	2.13	2.29	0.084	0.090
e	1.50 BSC		0.059 BSC	
e1	3.00 BSC		0.118 BSC	
H	3.94	4.25	0.155	0.167
L	0.89	1.20	0.035	0.047

Note : Follow JEDEC TO-243 AA.

Carrier Tape & Reel Dimensions

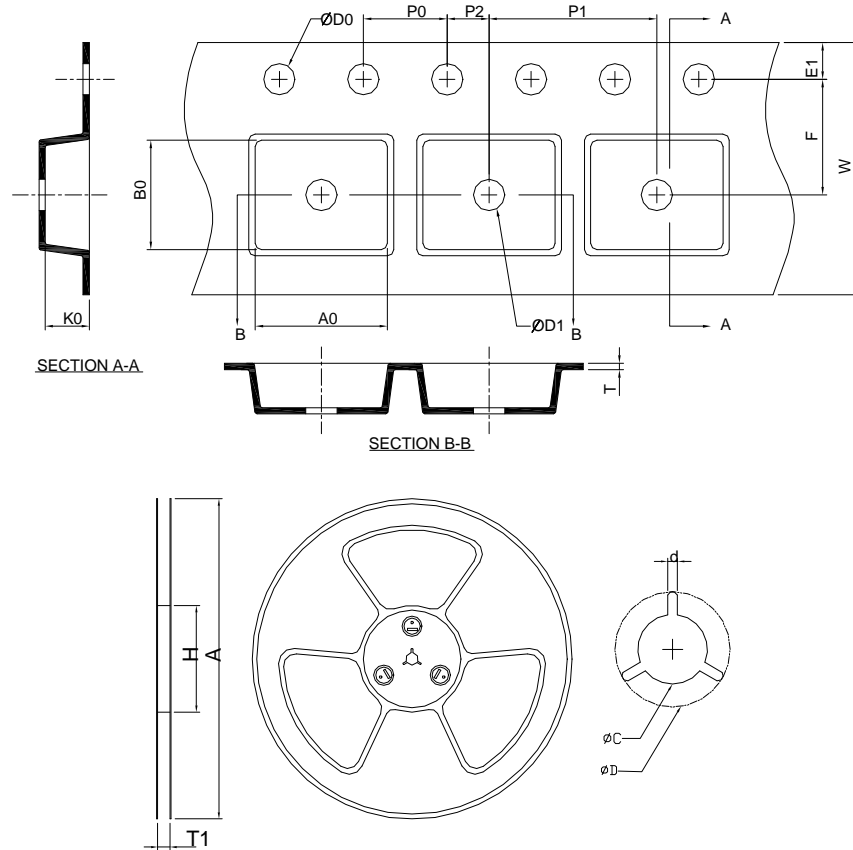

Application	A	H	T1	C	d	D	W	E1	F
SOT-89	178.0 ±0.00	50 MIN.	12.4+2.00 -0.00	13.0+0.50 -0.20	1.5 MIN.	20.2 MIN.	12.0 ±0.30	1.75 ±0.10	5.50 ±0.05
	P0	P1	P2	D0	D1	T	A0	B0	K0
	4.0 ±0.10	8.0 ±0.10	2.0 ±0.05	1.5+0.10 -0.00	1.5 MIN.	0.6+0.00 -0.40	4.80 ±0.20	4.50 ±0.20	1.80 ±0.20

(mm)

Devices Per Unit

Package Type	Unit	Quantity
SOT-89	Tape & Reel	1000

Taping Direction Information

SOT-89

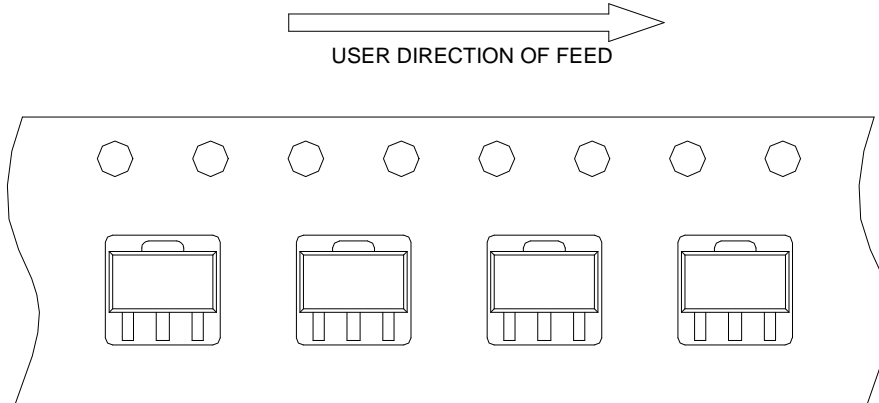

Reflow Condition (IR/Convection or VPR Reflow)

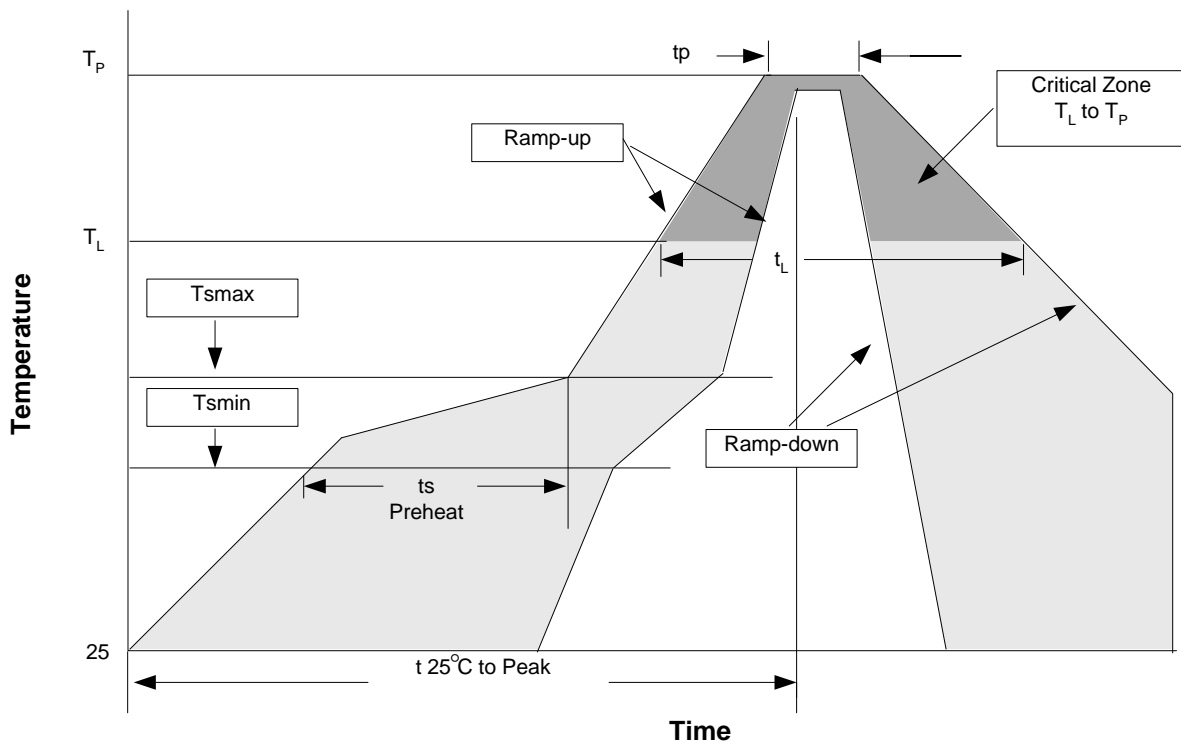

Reliability Test Program

Test item	Method	Description
SOLDERABILITY	MIL-STD-883D-2003	245°C, 5 sec
HOLT	MIL-STD-883D-1005.7	1000 Hrs Bias @ 125°C
PCT	JESD-22-B, A102	168 Hrs, 100%RH, 121°C
TST	MIL-STD-883D-1011.9	-65°C~150°C, 200 Cycles
ESD	MIL-STD-883D-3015.7	VHBM > 2KV, VMM > 200V
Latch-Up	JESD 78	10ms, 1tr > 100mA

Classification Reflow Profiles

Profile Feature	Sn-Pb Eutectic Assembly	Pb-Free Assembly
Average ramp-up rate (T _L to T _P)	3°C/second max.	3°C/second max.
Preheat - Temperature Min (T _{min}) - Temperature Max (T _{max}) - Time (min to max) (ts)	100°C 150°C 60-120 seconds	150°C 200°C 60-180 seconds
Time maintained above: - Temperature (T _L) - Time (t _L)	183°C 60-150 seconds	217°C 60-150 seconds
Peak/Classification Temperature (T _p)	See table 1	See table 2
Time within 5°C of actual Peak Temperature (tp)	10-30 seconds	20-40 seconds
Ramp-down Rate	6°C/second max.	6°C/second max.
Time 25°C to Peak Temperature	6 minutes max.	8 minutes max.

Note: All temperatures refer to topside of the package. Measured on the body surface.

Table 1. SnPb Eutectic Process – Package Peak Reflow Temperatures

Package Thickness	Volume mm ³ <350	Volume mm ³ ≥350
<2.5 mm	240 +0/-5°C	225 +0/-5°C
≥2.5 mm	225 +0/-5°C	225 +0/-5°C

Table 2. Pb-free Process – Package Classification Reflow Temperatures

Package Thickness	Volume mm ³ <350	Volume mm ³ 350-2000	Volume mm ³ >2000
<1.6 mm	260 +0°C*	260 +0°C*	260 +0°C*
1.6 mm – 2.5 mm	260 +0°C*	250 +0°C*	245 +0°C*
≥2.5 mm	250 +0°C*	245 +0°C*	245 +0°C*

* Tolerance: The device manufacturer/supplier **shall** assure process compatibility up to and including the stated classification temperature (this means Peak reflow temperature +0°C. For example 260°C+0°C) at the rated MSL level.

Customer Service

Anpec Electronics Corp.

Head Office :

No.6, Dusing 1st Road, SBIP,
Hsin-Chu, Taiwan, R.O.C.
Tel : 886-3-5642000
Fax : 886-3-5642050

Taipei Branch :

2F, No. 11, Lane 218, Sec 2 Jhongsing Rd.,
Sindian City, Taipei County 23146, Taiwan
Tel : 886-2-2910-3838
Fax : 886-2-2917-3838