

1A, Low Dropout Fast Response Positive Regulator Fixed 3.3V and 5.0V

Features

- Guaranteed Output Voltage Accuracy within 2%
- Fast Transient Response
- Guaranteed Dropout Voltage at Multiple Currents
- Load Regulation : 0.1% Typ.
- Line Regulation : 0.03% Typ.
- Low Dropout Voltage : 1.2V Typ. at $I_{OUT}=0.8A$
- Current Limit : 1A Typ. at $T_j=125\text{ }^\circ\text{C}$
- On-Chip Thermal Limiting : 150 $^\circ\text{C}$ Typ.
- Standard 3-pin SOT-223 and TO-252 Power Packages

Applications

- Active SCSI Terminators
- Low Voltage Logic Supplies
- Battery-Powered Circuitry
- Post Regulator for Switching Power Supply

General Description

The APL1117D/R is a low dropout three-terminal fixed 3.3V and 5.0V regulators with 1A output current capability. In order to obtain lower dropout voltage and faster transient response, which is critical for low voltage applications, the APL1117D/R has been optimized. The dropout voltage is guaranteed at a maximum of 1.3V at 0.8A. Current limit is trimmed to ensure specified output current and controlled short-circuit current. On-chip thermal limiting provides protection against any combination of overload that would create excessive junction temperatures. The APL1117D/R is available in the industry standard 3-pin SOT-223 and TO-252 the low profile surface mount packages which can be used in applications where space is limited.

Pin Description

Front View for SOT-223

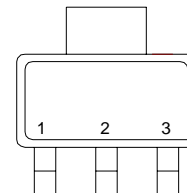

APL1117D

GND V_{OUT} V_{IN}

APL1117R

V_{IN} GND V_{OUT}

Front View for TO-252

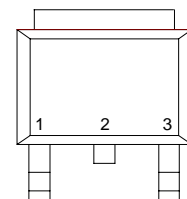

APL1117D





GND V_{OUT} V_{IN}

APL1117R

V_{IN} GND V_{OUT}

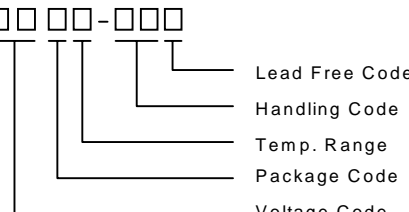
ANPEC reserves the right to make changes to improve reliability or manufacturability without notice, and advise customers to obtain the latest version of relevant information to verify before placing orders.

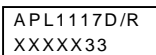
Ordering and Marking Information

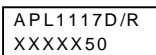
APL1117D/R-□□□□-□□□□ 	Package Code U : TO-252 V : SOT-223 Temp. Range C : 0 to 70 °C Handling Code TU : Tube TR : Tape & Reel Voltage Code 33 : 3.3V 50 : 5.0V Lead Free Code L : Lead Free Device Blank : Original Device
APL1117D/R-33U :  XXXXX - Date Code	APL1117D/R-33U :  XXXXX - Date Code
APL1117D/R-50U :  XXXXX - Date Code	APL1117D/R-50U :  XXXXX - Date Code

Absolute Maximum Ratings

Symbol	Parameter	Rating	Unit
V_I	Input Voltage	13.2	V
T_J	Operating Junction Temperature Range Control Section Power Transistor	0 to 125 0 to 150	°C
T_{STG}	Storage Temperature Range	-65 to +150	°C
T_L	Lead Temperature (Soldering, 10 second)	260	°C

Electrical Characteristics

Symbol	Parameter	Test Conditions	APL1117D/R			Unit
			Min.	Typ.	Max.	
V_{OUT}	APL1117D/R-33	$T_J=0\sim 125^\circ\text{C}$,	3.235	3.300	3.365	V
	APL1117D/R-50	$0\leq I_{OUT}\leq 0.8\text{A}$, $4.75\text{V}\leq V_{IN}\leq 12\text{V}$	4.900	5.000	5.100	
REG _{LINE}	Line Regulation	$T_J=0\sim 125^\circ\text{C}$, $I_{OUT}=0.8\text{A}$, $4.75\text{V}\leq V_{IN}\leq 7.75\text{V}$ (Note1)		1	6	mV
REG _{LOAD}	Load Regulation	$T_J=0\sim 125^\circ\text{C}$, $V_{IN}=4.75\text{A}$, $0\text{V}\leq I_{OUT}\leq 0.8\text{A}$ (Note1)		1	10	mV
V_D	Dropout Voltage	$I_{OUT}\leq 0.8\text{A}$, $T_J=0\sim 125^\circ\text{C}$		1.2	1.3	V
I_{LIMIT}	Current Limit	$(V_{IN}-V_{OUT})=5\text{V}$, $T_J=25^\circ\text{C}$		1		A
PSRR	Ripple Rejection	$F_{RIPPLE}=120\text{Hz}$, $V_{RIPPLE}=1\text{VP-P}$ $(V_{IN}-V_{OUT})=3\text{V}$, $T_J=0\sim 125^\circ\text{C}$	60	75		dB
T_R	Thermal Regulation	$T_J=25^\circ\text{C}$, 30ms Pulse		0.01		%/W
T_S	Temperature Stability			0.5		%
L_S	Long - Term Stability	$T_J=125^\circ\text{C}$, 1000Hrs		0.3		%

Electrical Characteristics

Symbol	Parameter	Test Conditions	APL1117D/R			Unit
			Min.	Typ.	Max.	
V_N	RMS Output Noise	$T_J=25^{\circ}\text{C}, 10\text{Hz}\leq F\leq 10\text{kHz}, (\% \text{ of } V_{\text{OUT}})$		0.003		%
θ_{th}	Thermal Resistance	Junction to Case, at Tab Junction to ambient		15 50		$^{\circ}\text{C}/\text{W}$
OT	Over Temperature Point			150		$^{\circ}\text{C}$
	Quiescent Current	$T_J=0\sim 125^{\circ}\text{C},$ $V_{\text{IN}}\leq 12\text{V}$		5.5	10	mA

Note 1: See thermal regulation specifications for changes in output voltage due to heating effects. Load line regulations are measured at a constant junction temperature by low duty cycle pulse testing.

Note 2: Dropout voltage is specified over the full output current range of the device. Dropout voltage is defined as the minimum input/output differential measured at the specified output current. Test points and limits are also shown on the Dropout Voltage curve.

Note 3: Minimum load current is defined as the minimum output current required to maintain regulation.

Application Schematic

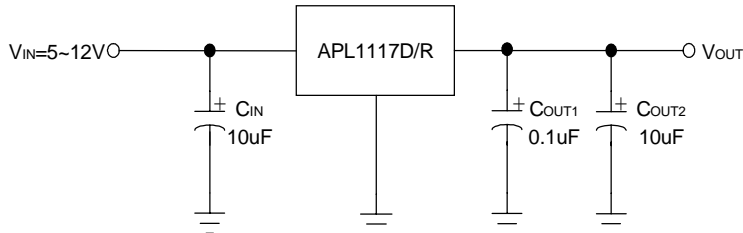

Typical Characteristics

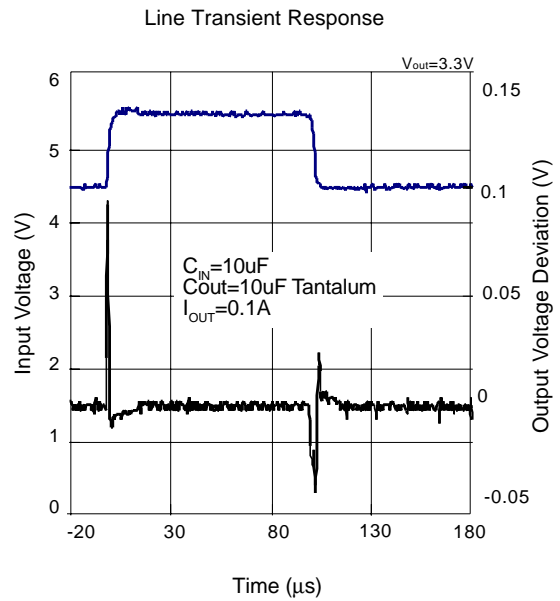
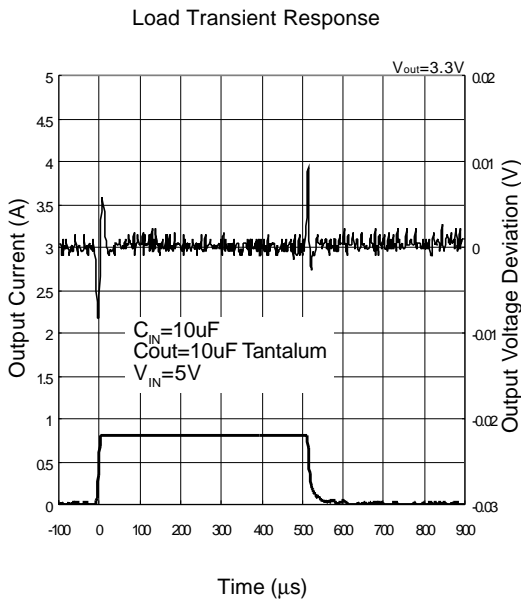
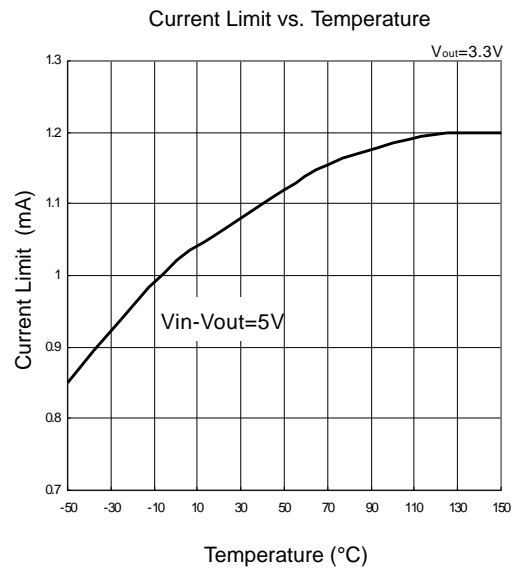
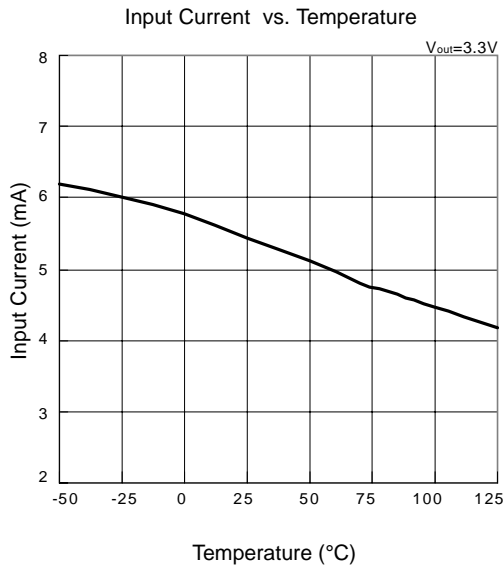

Typical Characteristics

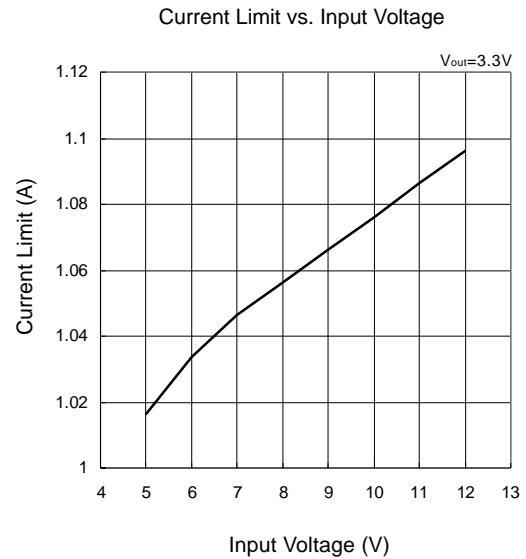
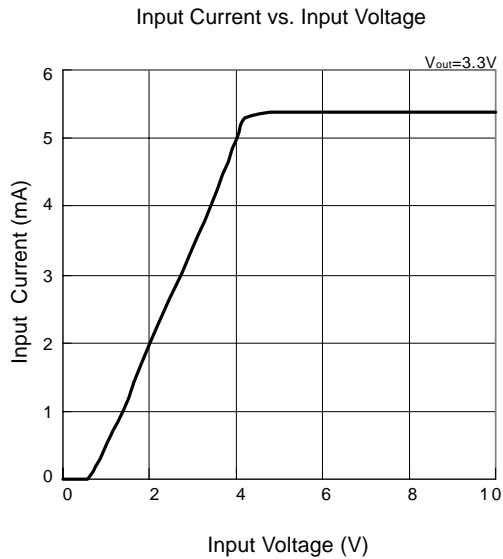
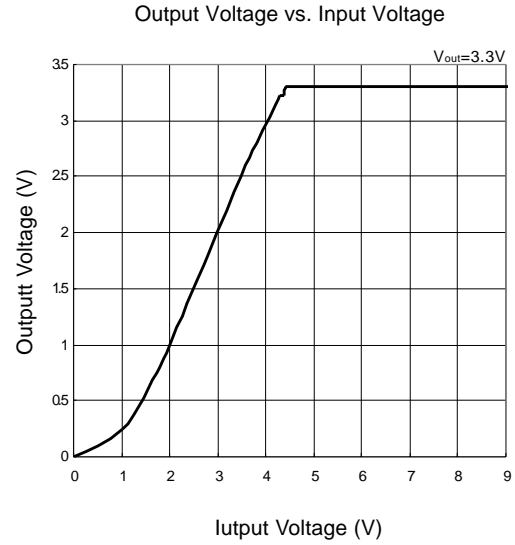
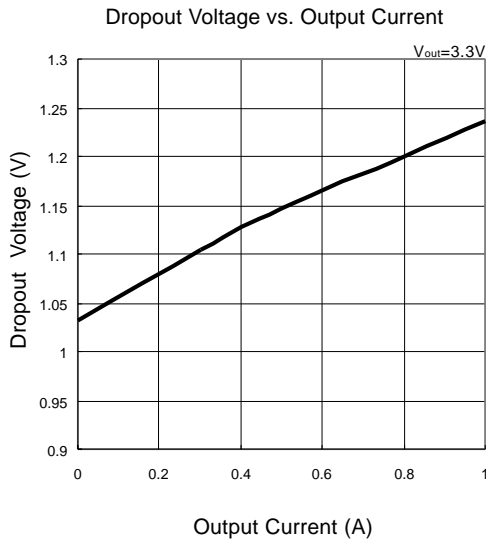

Typical Characteristics Cont.

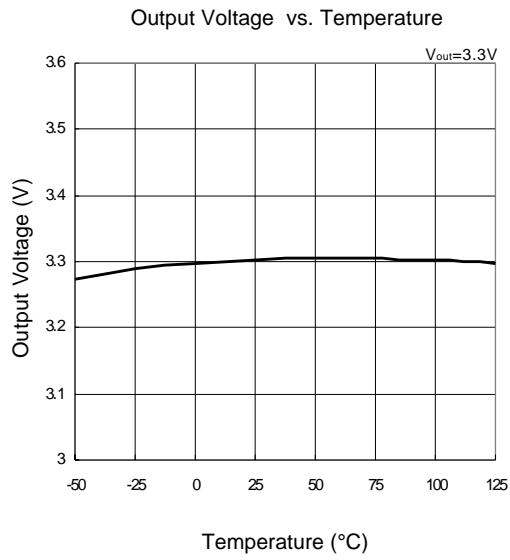

Package Information

SOT-223(Reference JEDEC Registration SOT-223)

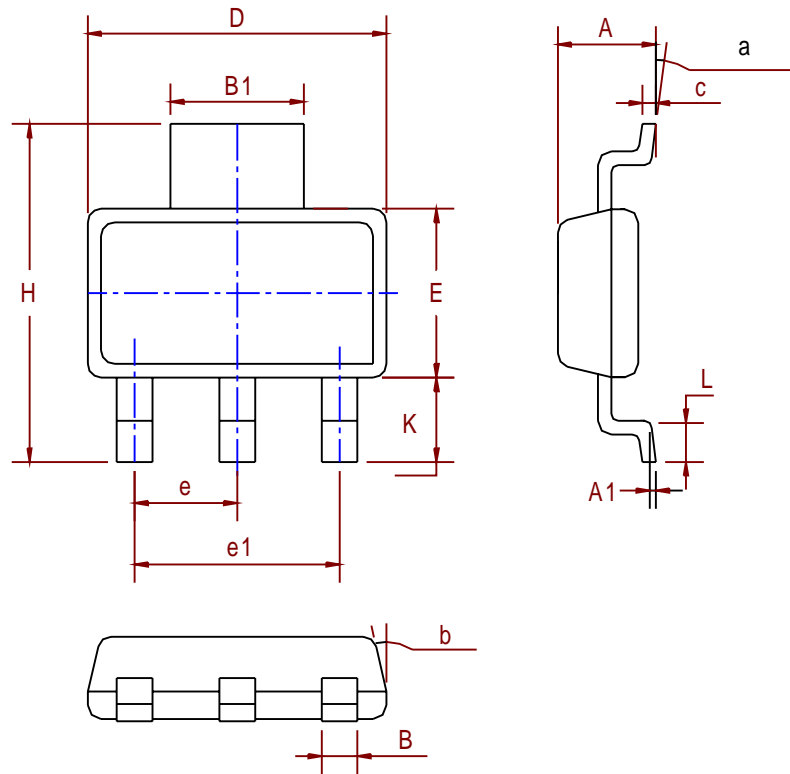

Dim	Millimeters		Inches	
	Min.	Max.	Min.	Max.
A	1.50	1.80	0.06	0.07
A1	0.02	0.08		
B	0.60	0.80	0.02	0.03
B1	2.90	3.10	0.11	0.12
c	0.28	0.32	0.01	0.01
D	6.30	6.70	0.25	0.26
E	3.30	3.70	0.13	0.15
e	2.3 BSC		0.09 BSC	
e1	4.6 BSC		0.18 BSC	
H	6.70	7.30	0.26	0.29
L	0.91	1.10	0.04	0.04
K	1.50	2.00	0.06	0.08
α	0°	10°	0°	10°
β	13°		13°	

Package Informaion

TO-252(Reference JEDEC Registration TO-252)

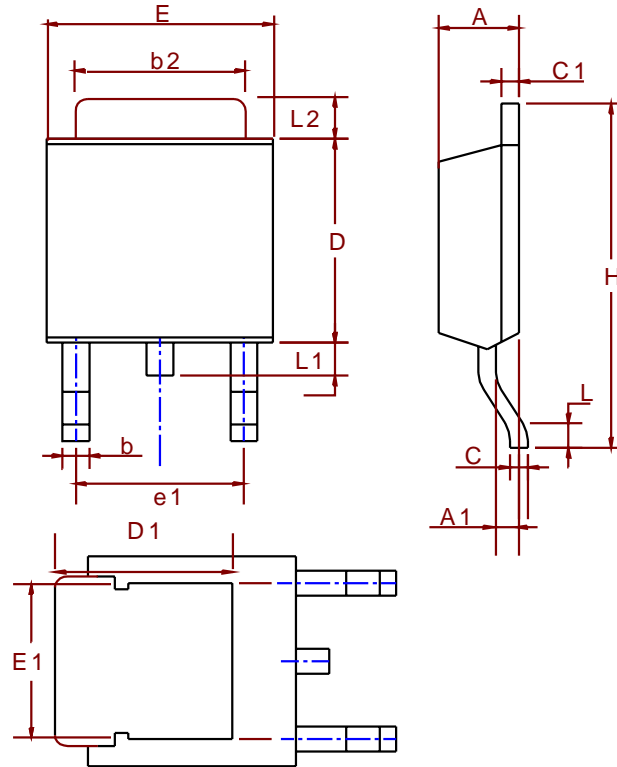

Dim	Millimeters		Inches	
	Min.	Max.	Min.	Max.
A	2.18	2.39	0.086	0.094
A1	0.89	1.27	0.035	0.050
b	0.508	0.89	0.020	0.035
b2	5.207	5.461	0.205	0.215
C	0.46	0.58	0.018	0.023
C1	0.46	0.58	0.018	0.023
D	5.334	6.22	0.210	0.245
D1	5.2 REF		0.205 REF	
E	6.35	6.73	0.250	0.265
E1	5.3 REF		0.209 REF	
e1	3.96	5.18	0.156	0.204
H	9.398	10.41	0.370	0.410
L	0.51		0.020	
L1	0.64	1.02	0.025	0.040
L2	0.89	2.032	0.035	0.080

Physical Specifications

Terminal Material	Solder-Plated Copper (Solder Material : 90/10 or 63/37 SnPb), 100%Sn
Lead Solderability	Meets EIA Specification RSI86-91, ANSI/J-STD-002 Category 3.

Reflow Condition (IR/Convection or VPR Reflow)

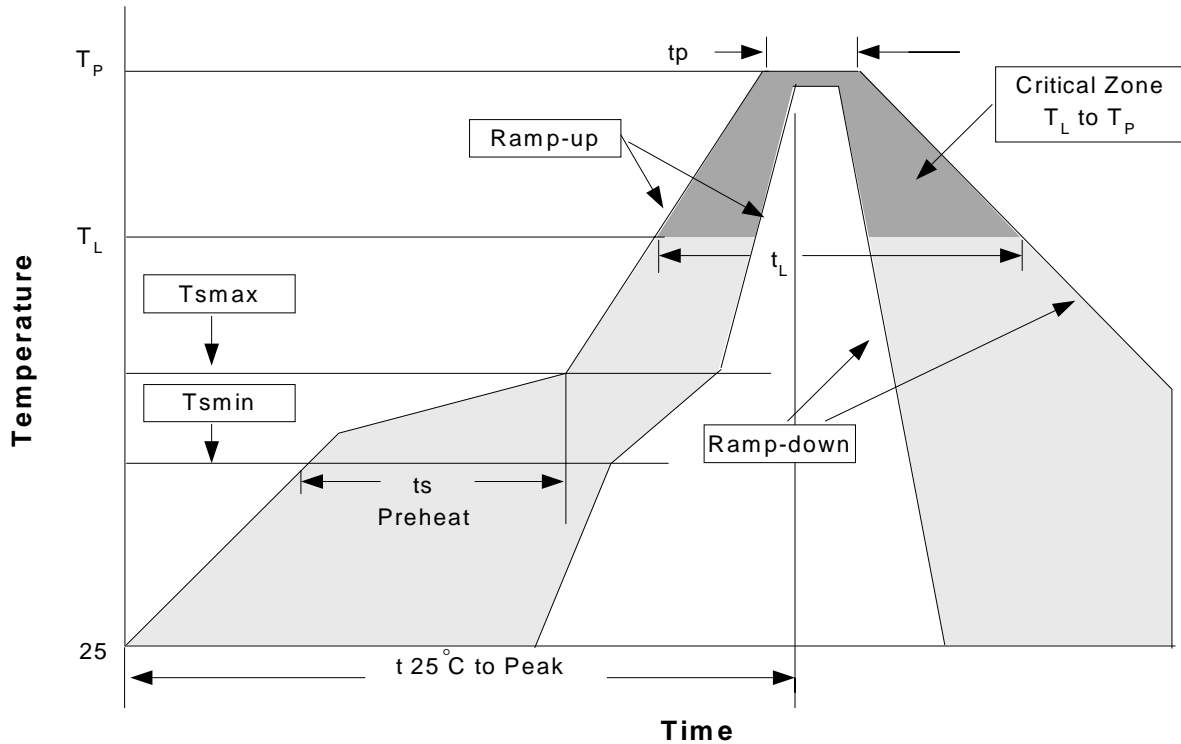

Classification Reflow Profiles

Profile Feature	Sn-Pb Eutectic Assembly		Pb-Free Assembly	
	Large Body	Small Body	Large Body	Small Body
Average ramp-up rate (T _L to T _P)	3°C/second max.		3°C/second max.	
Preheat				
- Temperature Min (T _{smin})	100°C		150°C	
- Temperature Mix (T _{smax})	150°C		200°C	
- Time (min to max)(t _s)	60-120 seconds		60-180 seconds	
T _{smax} to T _L				
- Ramp-up Rate			3°C/second max	
T _{smax} to T _L				
- Temperature(T _L)	183°C		217°C	
- Time (t _L)	60-150 seconds		60-150 seconds	
Peak Temperature(T _p)	225 +0/-5°C	240 +0/-5°C	245 +0/-5°C	250 +0/-5°C
Time within 5°C of actual Peak Temperature(t _p)	10-30 seconds	10-30 seconds	10-30 seconds	20-40 seconds
Ramp-down Rate	6°C/second max.		6°C/second max.	
Time 25°C to Peak Temperature	6 minutes max.		8 minutes max.	

Note: All temperatures refer to topside of the package. Measured on the body surface.

Reliability Test Program

Test item	Method	Description
SOLDERABILITY	MIL-STD-883D-2003	245°C, 5 SEC
HOLT	MIL-STD-883D-1005.7	1000 Hrs Bias @125°C
PCT	JESD-22-B,A102	168 Hrs, 100%RH, 121°C
TST	MIL-STD-883D-1011.9	-65°C~150°C, 200 Cycles
ESD	MIL-STD-883D-3015.7	VHBM > 2KV, VMM > 200V
Latch-Up	JESD 78	10ms, $1_{tr} > 100mA$

Carrier Tape

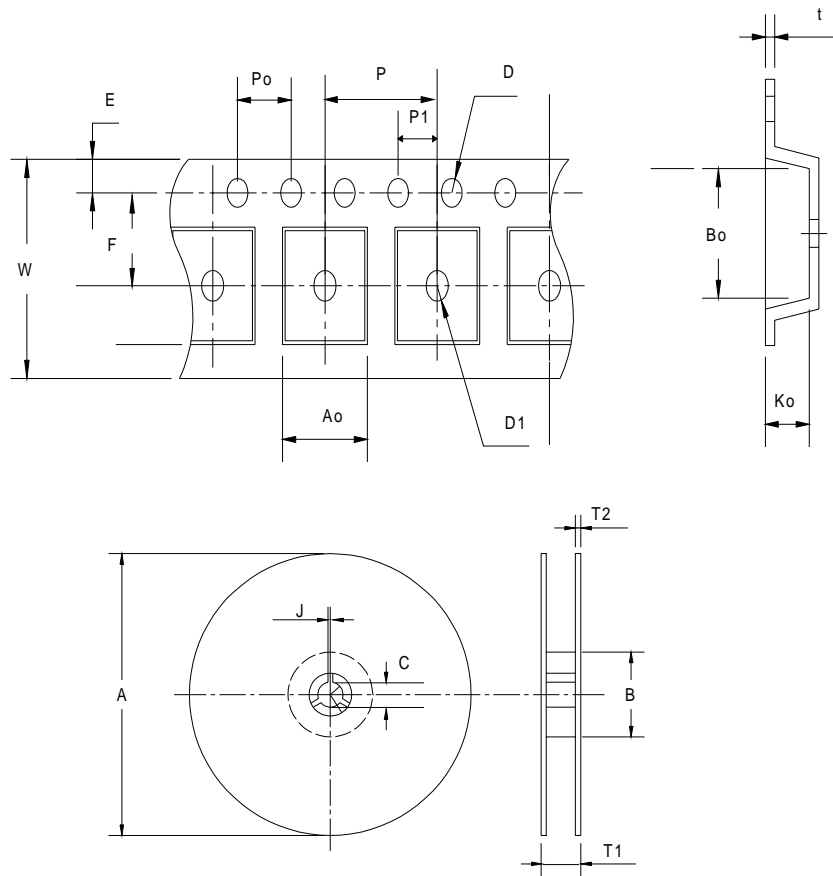

Carrier Tape

Application	A	B	C	J	T1	T2	W	P	E
TO-252	330±3	100 ± 2	13 ± 0.5	2 ± 0.5	16.4 +0.3 -0.2	2.5± 0.5	16 + 0.3 16 - 0.1	8 ± 0.1	1.75± 0.1
Application	F	D	D1	Po	P1	Ao	Bo	Ko	t
TO-252	7.5 ± 0.1	1.5± 0.1	1.5+ 0.25	4.0 ± 0.1	2.0 ± 0.1	6.8 ± 0.1	10.4± 0.1	2.5± 0.1	0.3±0.05
Application	A	B	C	J	T1	T2	W	P	E
SOT-223	330±1	62±1.5	12.75± 0.15	2 ± 0.6	12.4 +0.2	2± 0.2	12 ± 0.3	8 ± 0.1	1.75± 0.1
Application	F	D	D1	Po	P1	Ao	Bo	Ko	t
SOT-223	5.5 ± 0.05	1.5+ 0.1	1.5+ 0.1	4.0 ± 0.1	2.0 ± 0.05	6.9 ± 0.1	7.5± 0.1	2.1± 0.1	0.3±0.05

(mm)

Cover Tape Dimensions

Application	Carrier Width	Cover Tape Width	Devices Per Reel
SOT- 223	12	9.3	2500
TO- 252	16	13.3	2500

Customer Service

Anpec Electronics Corp.

Head Office :

5F, No. 2 Li-Hsin Road, SBIP,

Hsin-Chu, Taiwan, R.O.C.

Tel : 886-3-5642000

Fax : 886-3-5642050

Taipei Branch :

7F, No. 137, Lane 235, Pac Chiao Rd.,

Hsin Tien City, Taipei Hsien, Taiwan, R. O. C.

Tel : 886-2-89191368

Fax : 886-2-89191369