

## Low $I_Q$ , Low Dropout 150mA Fixed Voltage Regulator

### Features

- Low Noise :  $60\mu V_{RMS}$  (100Hz to 100kHz)
- Low Quiescent Current : 50uA
- Low Dropout Voltage : 220mV (@150mA)
- Very low Shutdown Current : < 0.5uA
- Fixed Output Voltage : 1.3V,1.4V,1.5V,1.6V, 1.7V,1.8V,1.9V, 2.0V,2.1V,2.2V,2.3V,2.4V, 2.5V,2.6V,2.7V, 2.8V,2.9V,3.0V,3.1V,3.2V, 3.3V,3.4V, 3.5V, 5.0V.
- Stable with 1uF Output Capacitor
- Stable with Aluminum , Tantalum or Ceramic Capacitors .
- Reverse Current Protection
- No Protection Diodes Needed
- Built in Thermal Protection
- Built in Current Limit Protection
- Controlled Short Circuit Current : 50mA
- Fast transient Response
- Short Setting Time
- SOT-23-5 Package

### Applications

- Notebook Computer
- PDA or Portable Equipments
- Noise-Sensitive Instrumentation Systems

### General Description

The APL5151/2/3/4 is micropower, low noise, low dropout linear regulator. Operate from 3V to 6V input voltage and deliver up to 150mA. Typical output noise is just  $60\mu V_{RMS}$  with the addition of an external 0.33uF bypass capacitor in BP pin and typical dropout voltage is only 220mV at 150mA loading. Designed for use in battery-powered system, the low 50uA quiescent current makes it an ideal choice. Design with an internal P-channel MOSFET pass transistor, the APL5151/2/3/4 maintains a low supply current, independent of the load current and dropout voltage. Other features include reverse current protection , thermal-shutdown protection , current limit protection to ensure specified output current and controlled short-circuit current . The APL5151/2/3/4 regulators come in a miniature SOT-23-5 package.

### Pin Configuration

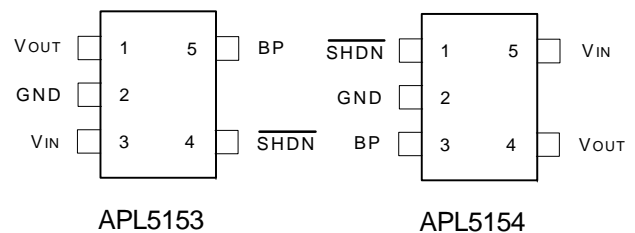
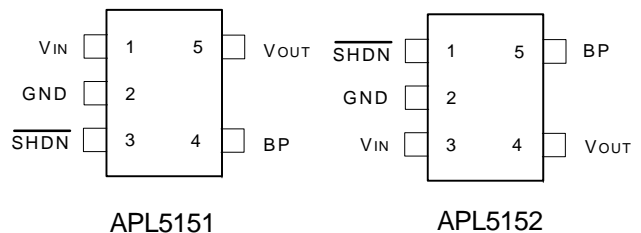

ANPEC reserves the right to make changes to improve reliability or manufacturability without notice, and advise customers to obtain the latest version of relevant information to verify before placing orders.

## Ordering and Marking Information

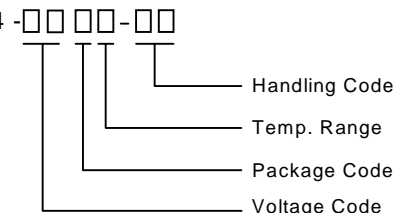
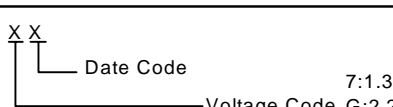
<p>APL5151/2/3/4 - □□ □□ - □□</p>  <p>Handling Code Temp. Range Package Code Voltage Code</p>	<p>Package Code B : SOT-23-5 Temp. Range C : 0 to 70°C                      I : -40 to 85°C Handling Code TR : Tape &amp; Reel Voltage Code : 13 : 1.3V ~ 50 : 5.0V(refer below for detailed)</p>
<p>151/2/3/4XX - XX</p>  <p>Date Code Voltage Code</p>	<p>7:1.3V 8:1.4V 9:1.5V A:1.6V B:1.7V C:1.8V D:1.9V E:2.0V F:2.1V G:2.2V H:2.3V I:2.4V J:2.5V K:2.6V L:2.7V M:2.8V N:2.9V O:3.0V P:3.1V Q:3.2V R:3.3V S:3.4V T:3.5V X:4.8V Y:4.9V Z:5.0V</p>

## Pin Description

PIN		I/O	Description
No.	Name		
1	V <sub>IN</sub>	I	Supply voltage input.
2	GND		Ground pins of the circuitry, and all ground pins must be soldered to PCB with proper power dissipation.
3	$\overline{\text{SHDN}}$	I	Shutdown control pin, low = off , high = normal .
4	BP/ADJ	O	Bypass signal pin in fixed output type device / Adjustable signal pin in adjustable output type device
5	V <sub>OUT</sub>	O	Output pin of the regulator.

## Absolute Maximum Ratings

Symbol	Parameter	Rating	Unit
V <sub>IN</sub> , V <sub>OUT</sub>	Input Voltage or Out Voltage	6	V
$\overline{\text{SHDN}}$	Shutdown Control Pin	6	V
R <sub>TH,JA</sub>	Thermal Resistance – Junction to Ambient	357	°C/W
P <sub>D</sub>	Power Dissipation	Internally Limited	W
T <sub>J</sub>	Operating Junction Temperature		°C
	Control Section	0 to 125	
	Power Transistor	0 to 150	
T <sub>STG</sub>	Storage Temperature Range	-65 to +150	°C
T <sub>L</sub>	Lead Temperature (Soldering, 10 second)	260	°C

## Electrical Characteristics

Unless otherwise noted these specifications apply over full temperature,  $V_{IN}=3.6V$ ,  $C_{IN}=C_{OUT}=1\mu F$ ,  $\overline{SHDN}=V_{IN}$ ,  $T_J=0$  to  $125^\circ C$ . Typical values refer to  $T_J=25^\circ C$ .

Symbol	Parameter	Test Conditions	APL5151/2/3/4			Unit
			Min.	Typ.	Max.	
$V_{IN}$	Input Voltage		2.7		6	V
$V_{OUT}$	Output Voltage	$V_{OUT}+1.0V < V_{CC} < 6.0V$ , $0mA < I_{OUT} < I_{MAX}$	$V_{OUT}-2\%$	$V_{OUT}$	$V_{OUT}+2\%$	V
$I_{LIMIT}$	Circuit Current Limit	$V_{IN}=V_{OUT}+1V$	250	300	350	mA
$I_{SHORT}$	Short Current	$V_{OUT}=0V$	40	50	60	mA
$I_{OUT}$	Load Current		150			mA
REG <sub>LINE</sub>	Line Regulation	$V_{OUT}+0.5V < V_{CC} < 6.0V$ , $0mA < I_{OUT} < I_{MAX}$		4	10	mV
REG <sub>LOAD</sub>	Load Regulation	$V_{IN} = V_{OUT}+1.0V$ , $0mA < I_{OUT} < I_{MAX}$		1	6	mV
	Load Transient	$V_{IN} = V_{OUT}+1V$ , $I_{OUT}=1mA-150mA$ in $1\mu s$		70	150	mV
$V_{DROP}$	Dropout Voltage <sup>(Note)</sup>	$I_{OUT} = 150mA$	$1.3V \leq V_{OUT} < 1.5V$	1.2	1.4	V
			$1.5V \leq V_{OUT} < 2.0$	1	1.2	
			$2.0V \leq V_{OUT} < 2.5$	0.7	0.8	
			$2.5V \leq V_{OUT} < 3$	0.5	0.6	
			$3V \leq V_{OUT} \leq 5$	0.3	0.4	
PSRR	Ripple Rejection	$F \leq 1kHz$ , $1V_{pp}$ at $V_{IN} = V_{OUT}+1.0V$ $C_{OUT}=10nf$	45	55		dB
$I_Q$	Quiescent Current	No load		50	80	$\mu A$
		$I_{OUT}=150mA$		135	170	
	Shutdown Supply Current	Shutdown = low $I_{OUT}=0$ , $V_{CC} = 6.0V$		0.01	1	$\mu A$
	Noise	$100Hz < f < 100kHz$ , typical load, $C_{BP}=0.1\mu F$ , $C_{OUT} = 1\mu F$		80		$\mu V_{rms}$
		$100Hz < f < 100kHz$ , typical load, $C_{BP}=0.33\mu F$ , $C_{OUT} = 1\mu F$		60		
	Shutdown Recovery Delay	$C_{BP}=0.1\mu F, C_{OUT}=1\mu F$ , no load		4		ms
		$C_{BP}=0.33\mu F, C_{OUT}=1\mu F$ , no load		13.2		
OTS	Over Temperature			150		$^\circ C$
	Over Temperature	Hysteresis		10		$^\circ C$
TC	Output Voltage Temperature Coefficient			50		ppm/ $^\circ C$

Note: Dropout voltage definition :  $V_{IN}-V_{OUT}$  when  $V_{OUT}$  is 2% below the value of  $V_{OUT}$  for  $V_{IN} = V_{OUT} + 0.5V$

## Electrical Characteristics Cont.

Unless otherwise noted these specifications apply over full temperature ,  $V_{IN}=3.6V$ ,  $C_{IN}=C_{OUT}=1\mu F$ ,  $SHDN=V_{IN}$ ,  $T_j=0$  to  $125^{\circ}C$  . Typical values refer to  $T_j=25^{\circ}C$  .

Symbol	Parameter	Test Conditions	APL5151/2/3/4			Unit
			Min.	Typ.	Max.	
$C_{OUT}$	Output Capacitor		0.8	1.0	2.6	$\mu F$
	ESR		0.02	0.1	1	Ohm
	Shutdown Input Threshold	$V_{OUT}+1.0V < V_{IN} < 6.0V$		1.6		V
$I_{SHDN}$	Shutdown input Bias current	$V_{SHDN} = V_{IN}$		0.01	100	nA
	Input Reverse Leakage current	$V_{OUT}-V_{IN}=0.1V$		0.1	0.5	$\mu A$
	Reverse Protection Threshold			11	50	mV

Note: Dropout voltage definition :  $V_{IN}-V_{OUT}$  when  $V_{OUT}$  is 2% below the value of  $V_{OUT}$  for  $V_{IN} = V_{OUT} + 0.5V$

## Application Circuit

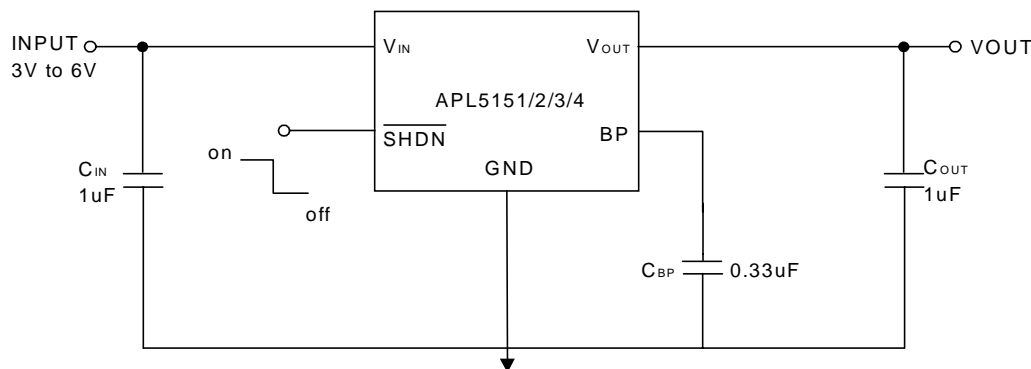

## Typical Characteristics

Current Limit vs. Input Voltage

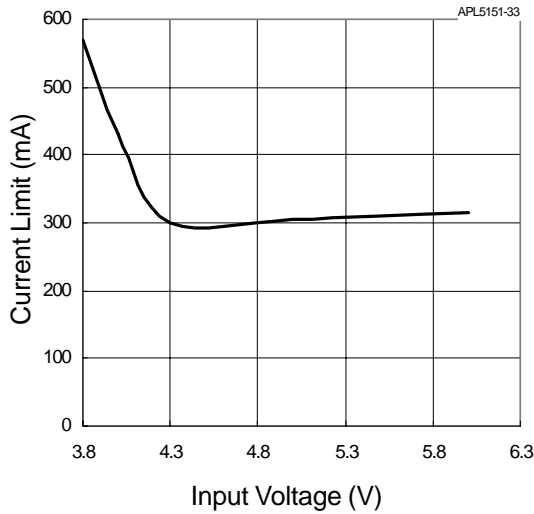

Ground Pin Current vs. Load Current

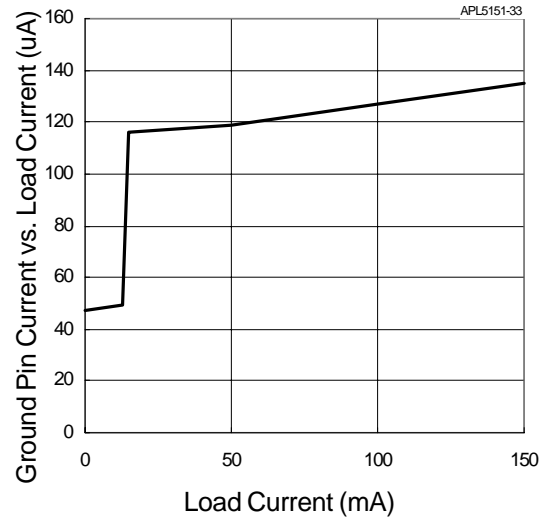

Ground Pin Current vs. Input Voltage

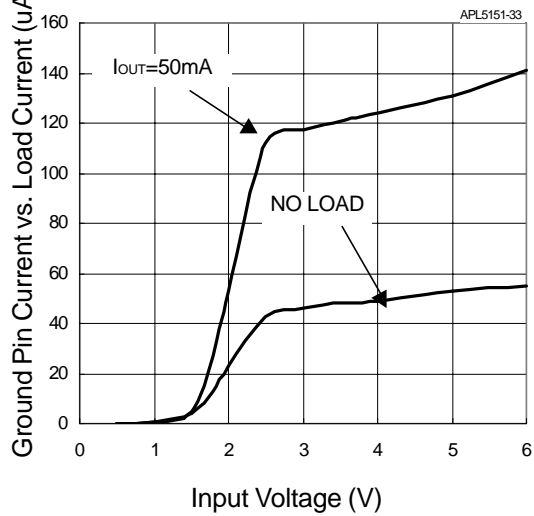

Input Voltage vs. Output Voltage

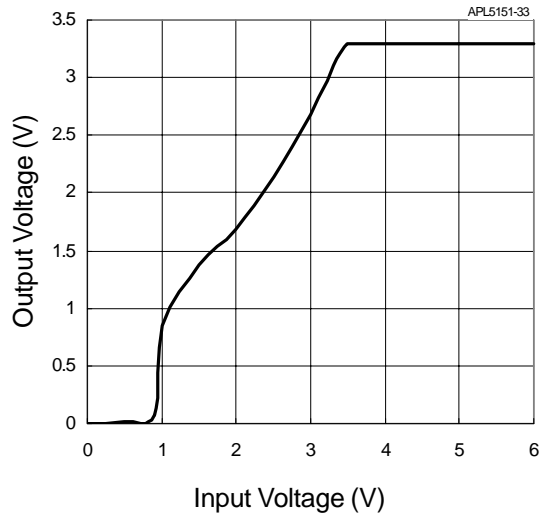

## Typical Characteristics

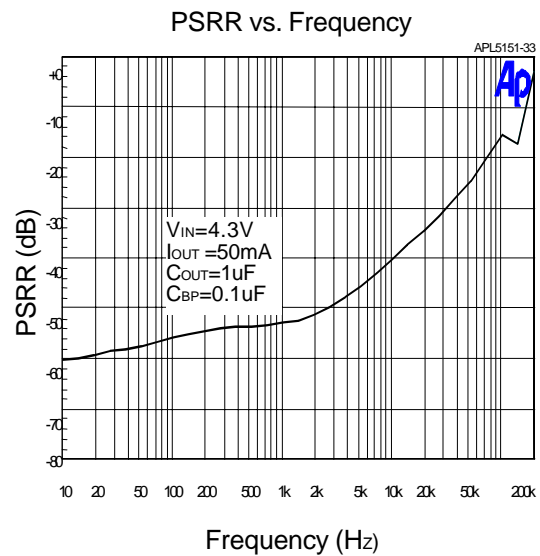
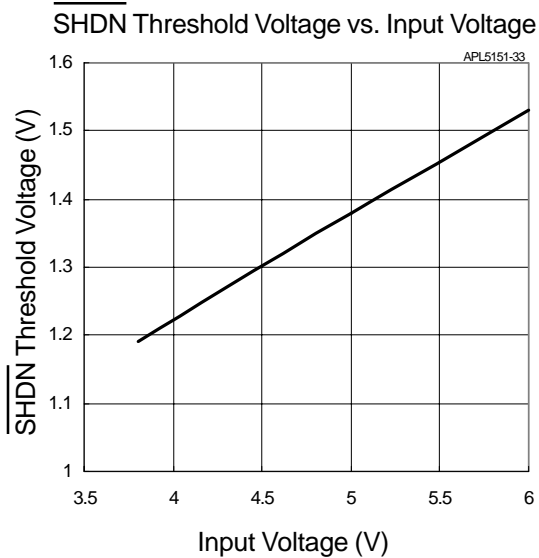
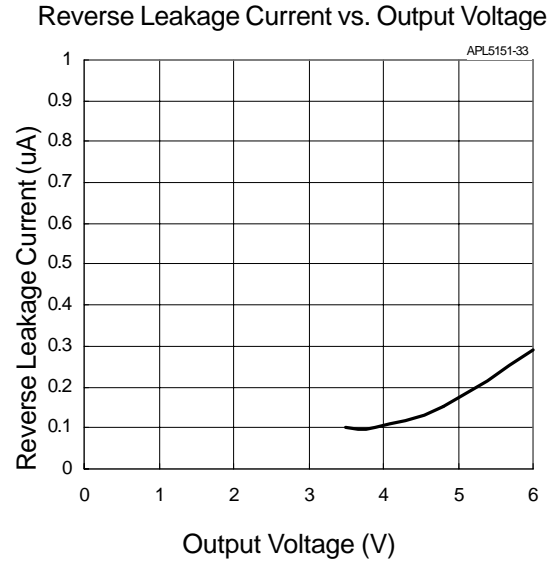
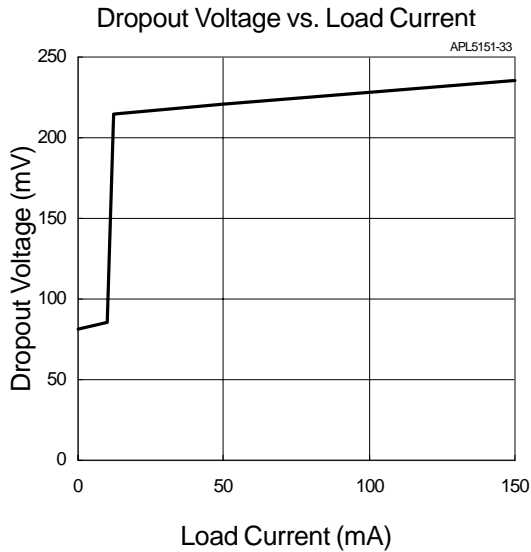

## Typical Characteristics

Output Noise

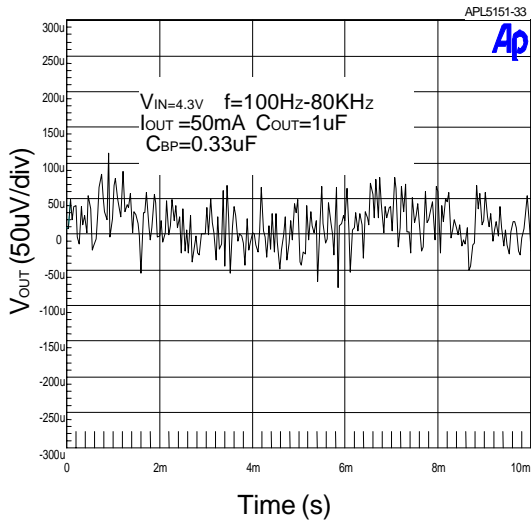

Output Noise vs. Bypass Capacitor

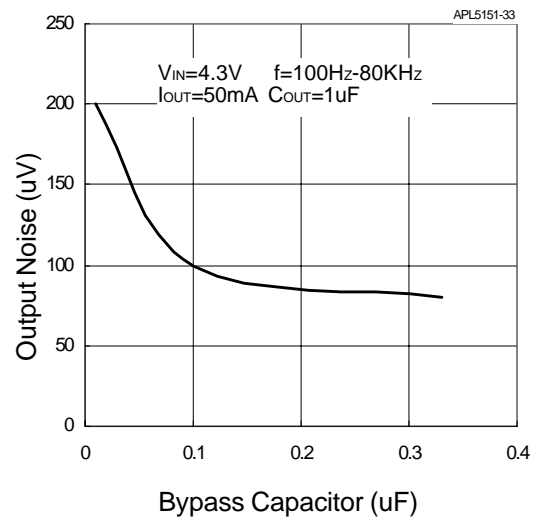

Load-Transient Response

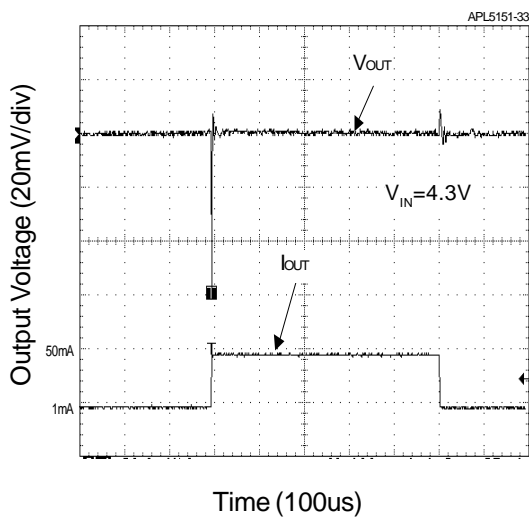

Line-Transient Response

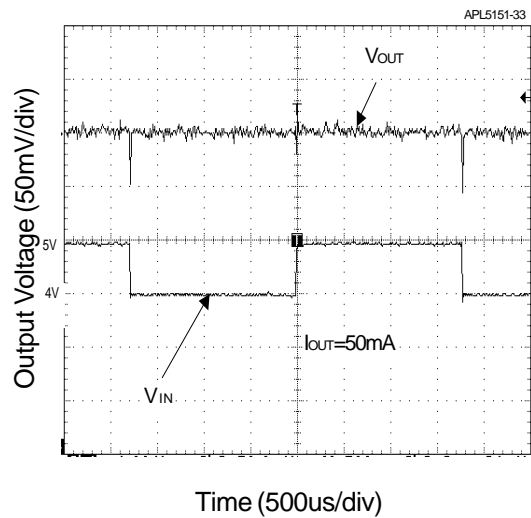

## Typical Characteristics

Shutdown Exit Delay

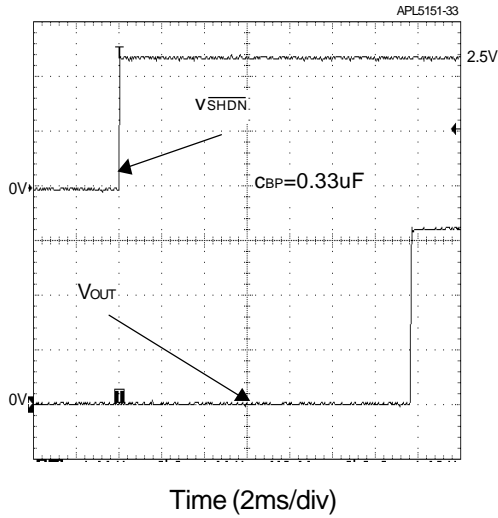

Shutdown Exit Delay

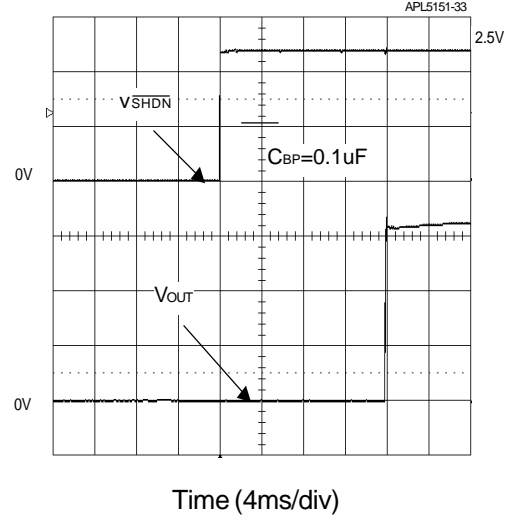

Entering Shutdown

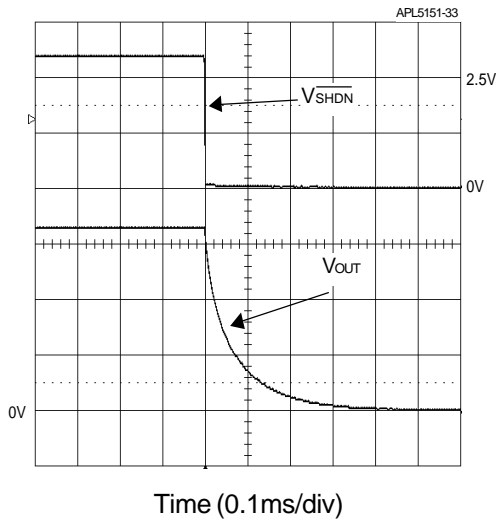

Region of Stable ESR vs. Load Current

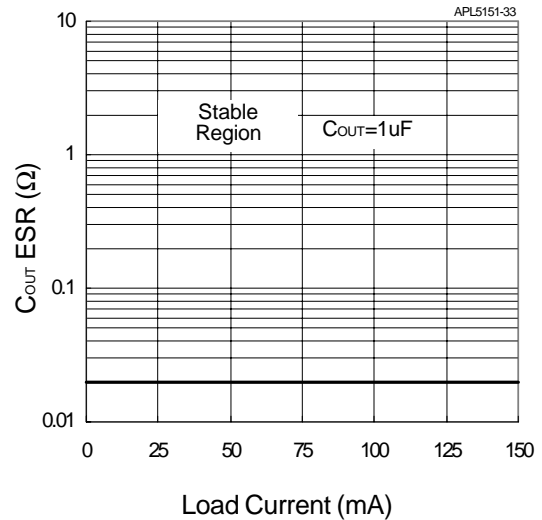



## Typical Characteristics

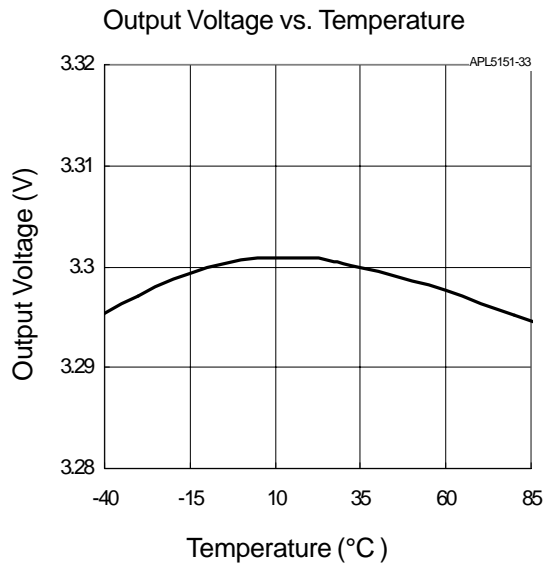

## Application Information

### Capacitor Selection and Regulator Stability

The APL5151/2/3/4 use at least a 1 $\mu$ F capacitor on the input. This capacitor can use Aluminum, Tantalum or Ceramic capacitors. Input capacitor with large values and low ESR provide better PSRR and line-transient response. The output capacitor also can use Aluminum, Tantalum or Ceramic capacitors, and its minimum values is recommended 1 $\mu$ F, ESR must be above 0.02 $\Omega$ . The Curve of the region of stable  $C_{OUT}$  ESR vs. load current in Typical Characteristics shows the output capacitor ESR and load current range for APL5151/2/3/4 stability. Large output capacitor values can reduce noise and improve load-transient response, stability, and PSRR. Note that some ceramic dielectrics exhibit large capacitance and ESR variation with Temperature. If use this capacitor, it may be necessary to use 2.2 $\mu$ F or more to ensure stability at temperature below -10 $^{\circ}$ C.

### Load-Transient Considerations

The APL5151/2/3/4 load-transient response graphs in Typical Characteristics show the transient response. A step change in the load current from 1mA to 50mA at 1 $\mu$  second will cause a 60mV transient spike. Large output capacitor's value and low ESR can reduce transient spike.

### Input-Output (Dropout)Voltage

The minimum input-output voltage differential (dropout) determines the lowest usable supply voltage. In battery-powered systems, this will determine the useful end-of-life battery voltage. Because the APL5151/2/3/4 use a P-channel MOSFET pass transistor, the dropout voltage is a function of drain-to-source on-resistance ( $R_{DS(ON)}$ ) multiplied by the load current.

### Reverse Current Protection

The APL5151/2/3/4 have a internal reverse protection, it does not need a external schottky diode to connect the regulator input and output. If the output voltage is forced above the input voltage by more than 11mV, the IC will be shutdown and the ground pin current is below 0.1 $\mu$ A, it will increase with the output voltage.

### Current Limit

The APL5151/2/3/4 have a current limit protection. The point where limiting occurs is 300mA when  $V_{IN}=4.3V$ , then output current will limit at 50mA. When the load current back to the value where limiting started, the output voltage and current will return to normal value. When APL5151/2/3/4 output voltage shorted to ground, the APL5151/2/3/4 will keep short circuit current in 50mA. So the output can be shorted to ground for an indefinite amount of time without damaging the device.

### Shutdown Operation

The APL5151/2/3/4 include a shutdown function, when shutdown pin is pulling to high, IC is turned on, shutdown pin is pulling to low, IC is turned off. Note the shutdown pin must not be floating. Use shutdown function, the logic signal of the shutdown pin must be above or below the shutdown pin threshold voltage. (See Electrical Characteristics).The logic shutdown input signal may come from any logic supply. The shutdown pin input voltage may exceed the input voltage, but must be not over the absolute maximum ratings voltage.

## Thermal Protection

Thermal protection Limits total power dissipation in the APL5151/2/3/4. When the junction Temperature exceeds  $T_J=+150^{\circ}\text{C}$ , the thermal sensor generate a logic signal to turn off the pass transistor and allowing IC to cool. When the IC's junction temperature cools by  $10^{\circ}\text{C}$ , the thermal sensor will turn the pass transistor on again, resulting in a pulsed output during continuous thermal protection. Thermal protection is designed to protect the APL5151/2/3/4 in the event of fault conditions. For continual operation, do not exceed the absolute maximum junction temperature rating of  $T_J=+150^{\circ}\text{C}$ .

## Operating Region and Power Dissipation

The thermal resistance of the case and circuit board, ambient and junction air temperature, and the rate of air flow all control the APL5151/2/3/4's maximum power dissipation. The power dissipation across the device is  $P = I_{\text{OUT}}(V_{\text{IN}} - V_{\text{OUT}})$ . The maximum power dissipation is:

$$P_{\text{MAX}} = (T_J - T_A) / (\theta_{\text{JC}} + \theta_{\text{CA}})$$

where  $T_J - T_A$  is the temperature difference between the junction and ambient air,  $\theta_{\text{JC}}$  is the thermal resistance of the package, and  $\theta_{\text{CA}}$  is the thermal resistance through the printed circuit board, copper traces, and other materials to the ambient air.

The GND pin of the APL5151/2/3/4 provides an electrical connection to ground and channeling heat away. If power dissipation is large, connect the GND pin to ground using a large pad or ground plane, can improve the problem of over heat of IC.

## Packaging Information

SOT-23-5

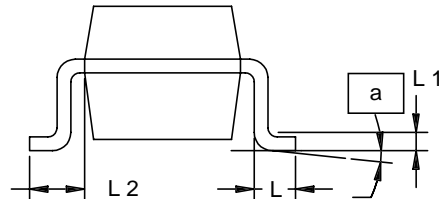
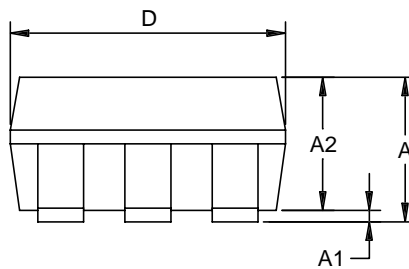
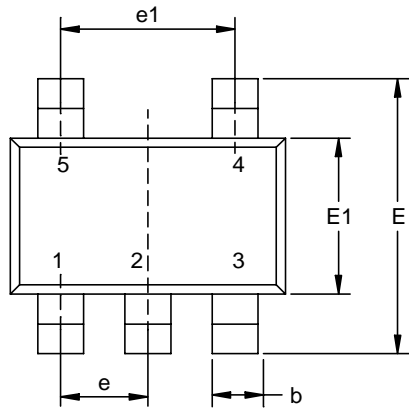

Dim	Millimeters		Inches	
	Min.	Max.	Min.	Max.
A	0.95	1.45	0.037	0.057
A1	0.05	0.15	0.002	0.006
A2	0.90	1.30	0.035	0.051
D	2.8	3.00	0.110	0.118
E	2.6	3.00	0.102	0.118
E1	1.5	1.70	0.059	0.067
L	0.35	0.55	0.014	0.022
L1	0.20 BSC		0.008 BSC	
L2	0.5	0.7	0.020	0.028
N	5		5	
$\alpha$	0°	10°	0°	10°

## Physical Specifications

Terminal Material	Solder-Plated Copper (Solder Material : 90/10 or 63/37 SnPb)
Lead Solderability	Meets EIA Specification RSI86-91, ANSI/J-STD-002 Category 3.

## Reflow Condition (IR/Convection or VPR Reflow)

Reference JEDEC Standard J-STD-020A APRIL 1999

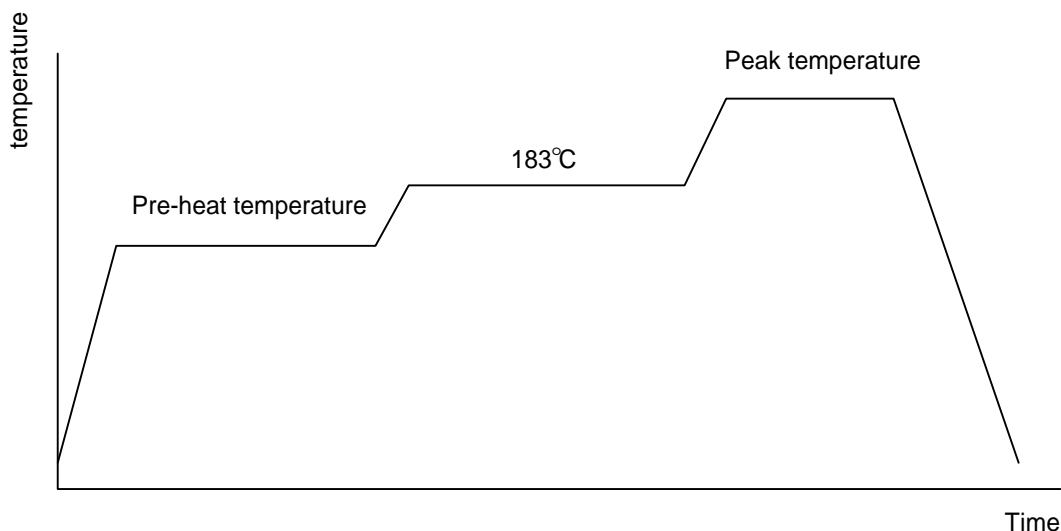

## Classification Reflow Profiles

	Convection or IR/ Convection	VPR
Average ramp-up rate(183°C to Peak)	3°C/second max.	10 °C /second max.
Preheat temperature 125 ± 25°C)	120 seconds max	
Temperature maintained above 183°C	60 – 150 seconds	
Time within 5°C of actual peak temperature	10 –20 seconds	60 seconds
Peak temperature range	220 +5/-0°C or 235 +5/-0°C	215-219°C or 235 +5/-0°C
Ramp-down rate	6 °C /second max.	10 °C /second max.
Time 25°C to peak temperature	6 minutes max.	

## Package Reflow Conditions

pkg. thickness ≥ 2.5mm and all bgas	pkg. thickness < 2.5mm and pkg. volume ≥ 350 mm <sup>3</sup>	pkg. thickness < 2.5mm and pkg. volume < 350mm <sup>3</sup>
Convection 220 +5/-0 °C		Convection 235 +5/-0 °C
VPR 215-219 °C		VPR 235 +5/-0 °C
IR/Convection 220 +5/-0 °C		IR/Convection 235 +5/-0 °C

### Reliability test program

Test item	Method	Description
SOLDERABILITY	MIL-STD-883D-2003	245°C , 5 SEC
HOLT	MIL-STD-883D-1005.7	1000 Hrs Bias @ 125 °C
PCT	JESD-22-B, A102	168 Hrs, 100 % RH , 121°C
TST	MIL-STD-883D-1011.9	-65°C ~ 150°C, 200 Cycles
ESD	MIL-STD-883D-3015.7	VHBM > 2KV, VMM > 200V
Latch-Up	JESD 78	10ms , I <sub>tr</sub> > 100mA

### Carrier Tape

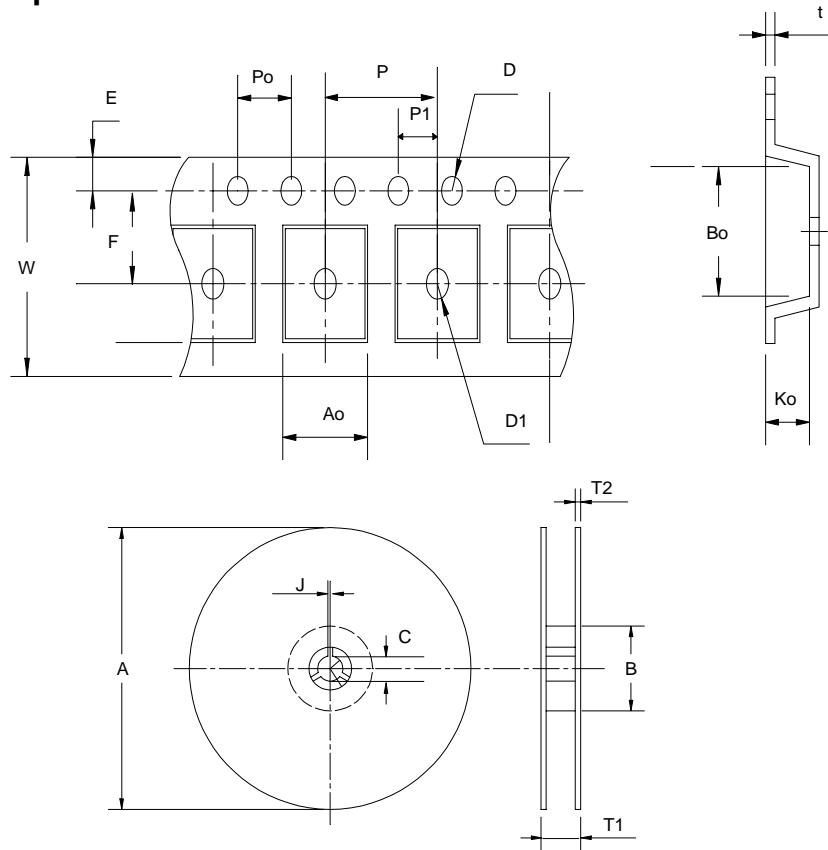

Application	A	B	C	J	T1	T2	W	P	E
SOT-23-5	178±1	72 ± 1.0	13.0 + 0.2	2.5 ± 0.15	8.4 ± 2	1.5± 0.3	8.0 <sup>+ 0.3</sup> <sub>- 0.3</sub>	4 ± 0.1	1.75± 0.1
	F	D	D1	P <sub>o</sub>	P1	A <sub>o</sub>	B <sub>o</sub>	K <sub>o</sub>	t
	3.5 ± 0.05	1.5 + 0.1	1.5 + 0.1	4.0 ± 0.1	2.0 ± 0.1	3.15 ± 0.1	3.2± 0.1	1.4± 0.1	0.2±0.03

## Cover Tape Dimensions

Application	Carrier Width	Cover Tape Width	Devices Per Reel
SOT- 23	8	5.3	3000

## Customer Service

### **Anpec Electronics Corp.**

Head Office :

5F, No. 2 Li-Hsin Road, SBIP,

Hsin-Chu, Taiwan, R.O.C.

Tel : 886-3-5642000

Fax : 886-3-5642050

Taipei Branch :

7F, No. 137, Lane 235, Pac Chiao Rd.,

Hsin Tien City, Taipei Hsien, Taiwan, R. O. C.

Tel : 886-2-89191368

Fax : 886-2-89191369