

150mA CMOS Low Dropout Regulator With Power OK

Features

- Ultra low ground current : 60μA
- Low Dropout Voltage Regulator, 1.5V
- 150mA Load Current Capability
- Output Voltage Accuracy : ±2% Over Temp.
- Input Voltage Range of 2.7V to 6.0V
- Power Good (POK) Function
- Current Limit Protection
- Thermal Shutdown Protection
- Fast Transient Response
- Stability with low-ESR capacitors
- TTL Logic controlled enable input
- SOT-23-5 Package

General Description

The APL5158 is a precise CMOS LDO with power ok function. The APL5158 offers 2% output accuracy over temp, and an ultra low ground current 60μA. The power good function monitors the output voltage and indicates when an error occurs in the system (active low). In the event of an output fault such as over current, thermal shutdown, the power ok output is pulled low. The APL5158 also works with low-ESR output capacitors, reducing the amount of board space for power applications, critical in hand-held wireless devices. Key features include current-limit, thermal shutdown, fast transient response. A compact package SOT-23-5 is available for space saving purpose.

Applications

- Processor power up sequencing
- Laptop, notebook, and palmtop computers
- Wireless LAN

Pin Configuration

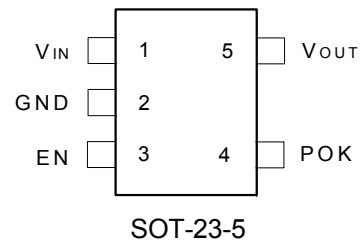

Ordering and Marking Information

<p>APL5158 - □□□□-□□□□</p> <p style="margin-left: 40px;"> Lead Free Code Handling Code Temp. Range Package Code Voltage Code </p>	<p>Package Code B : SOT-23-5</p> <p>Temp. Range C : 0 to 70°C</p> <p>Handling Code TR : Tape & Reel</p> <p>Voltage Code : 12 : 1.2V</p> <p>Lead Free Code L : Lead Free Device Blank : Original Device</p>
<div style="border: 1px solid black; display: inline-block; padding: 2px;">185X</div>	<p>5 - 1.2V X - Date Code</p>

ANPEC reserves the right to make changes to improve reliability or manufacturability without notice, and advise customers to obtain the latest version of relevant information to verify before placing orders.

Pin Description

PIN		I/O	Description
No.	Name		
1	V _{IN}	I	Input supply voltage.
2	GND		Ground pin for signal ground and power ground.
3	EN	I	Enable/shutdown input (active high). Do not leave open.
4	POK	O	Power OK indicator.
5	V _{OUT}	O	Regulator output voltage.

Block Diagram

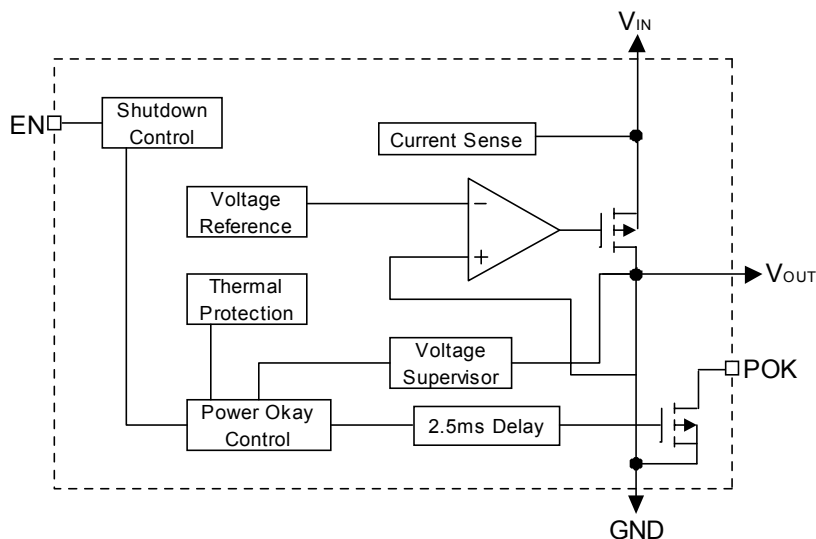

Absolute Maximum Ratings

Symbol	Parameter	Rating	Unit
V _{IN}	Input Voltage	7	V
V _{EN}	Enable Input Voltage	7	V
P _D	Power Dissipation	Internally Limited	W
T _J	Junction Temperature	150	°C
T _{STG}	Storage Temperature	-65 to +150	°C
T _s	Soldering Temperature (10 seconds)	300	°C
ESD	ESD Classification	2	kV

Thermal Characteristics

Symbol	Parameter	Rating	Unit
θ_{JA}	Thermal Resistance in Free Air SOT-23-5	260	$^{\circ}\text{C}/\text{W}$

Electrical Characteristics

$T_A=25^{\circ}\text{C}$, $V_I=5\text{V}$, $V_{(EN)}=V_I$, $I_O=100\mu\text{A}$, $C_L=1\mu\text{F}$, unless otherwise specified.

Symbol	Parameter	Test Conditions	APL5158			Unit
			Min.	Typ.	Max.	
V_{IN}	Input Voltage		2.7		6	V
V_{OUT}	Output Voltage	$I_O=25\text{mA}$		1.2		V
	Output Voltage Accuracy	$I_O=0\text{mA}$	-1.0		+1.0	%
I_Q	Quiescent Current	$V_{(EN)} \leq 0.8\text{V}$		0.45	1	μA
		$I_O=1\sim 150\text{mA}, T_A=0^{\circ}\text{C}$ to 70°C	-2.0		+2.0	%
I_{GND}	Ground Terminal Current	$I_O=0\text{mA}$		60		μA
		$I_O=150\text{mA}$		370		μA
I_L	Output Load Current		150			mA
I_{LIMIT}	Output Current Limit		300	600		mA
ΔV_{LNR}	Line Regulation	$V_{IN}=2.7\text{V}$ to 6V	-0.1		+0.1	%
ΔV_{LDR}	Load Regulation	$I_O=10\text{mA}$ to 150mA		0.2	1	%
$V_{IN}-V_{OUT}$	Dropout Voltage	$I_O=100\mu\text{A}$		1.5		V
		$I_O=150\text{mA}$		1.5		V
C_L	Load Capacitance	ESR and Capacitance Tradeoffs		1		μF
I_{REV}	Reverse Output Current on V_{IN}	$V_{IN}=\text{GND}$, $V_{OUT}=\text{Regulated Voltage}$			4	mA
Enable Input						
V_{IL}	Enable Input Logic-Low Voltage	$V_{IN}=2.7\text{V}$ to 6V Regulated Shutdown			0.4	V
V_{IH}	Enable Input Logic-High Voltage	$V_{IN}=2.7\text{V}$ to 6V Regulated Enabled	1.6			V
I_{EN}	Enable Input Current	Shutdown, $V_{IL} \leq 0.8\text{V}$		0.01		μA
		Enabled, $V_{IH} \geq 2\text{V}$		0.01		μA
	Resistance Discharge	$V_{EN} \leq 0.8\text{V}$		500		Ω
Thermal Protection						
T_{SD}	Thermal Shutdown			150		$^{\circ}\text{C}$
T_{SDHYS}	Hysteresis			15		$^{\circ}\text{C}$
Power Good						
V_{POK}	Low Threshold	Output Falls % of V_{OUT} (Power not OK)			83	%
	High Threshold	Output Reaches % of V_O , Starts Delay Timer(Power OK)	90			%
V_{OL}	V_O Out of Regulation	Fault Condition, $I_{OL}=2\text{mA}$, $V_{IN}=3.3\text{V}$		0.13	0.15	V
I_{POK}	POK Leakage Current	Power good off, $V_{IN}=5\text{V}$			1	μA
Switching Characteristics						
	Power Up Overshoot	Max Voltage Overshoot Allowed on Output During Power Up		1		%
t_{STEP}	Output Transient Time Limit	Time for Output to Return within Specified Regulation Range		5		μs
	Output Transient Voltage Limit	Voltage that Load Step can Affect the Nominal Output Voltage		1		%

Electrical Characteristics Cont.

$T_A = 25^\circ\text{C}$, $V_I = 5\text{V}$, $V_{(EN)} = V_I$, $I_O = 100\mu\text{A}$, $C_L = 1\mu\text{F}$, unless otherwise specified.

Symbol	Parameter	Test Conditions	APL5158			Unit
			Min.	Typ.	Max.	
I_{SR}	Load Step Current Slew Rate	$I_L = 10\text{mA}$ to 150mA		10		$\text{mA}/\mu\text{s}$
t_r	Power Up Rise Time			3		ms
t_f	Power Down Fall Time	Discharge resistance= 500Ω , $V_O < 1.08\text{V}$		60		μs
V_{POK} Delay	Delay Time to Power Good		1	2.5	5	ms

Note 1 : Positive output current means the regulator is sourcing load current, and negative one is sinking load current.

Application Circuit

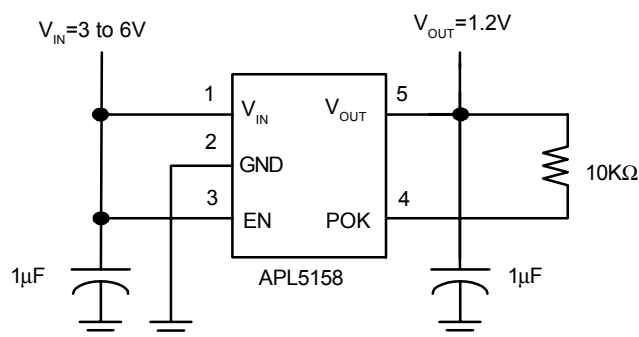

Typical Application For Processor VID Code Power Sequencing Schematic

Timing Chart

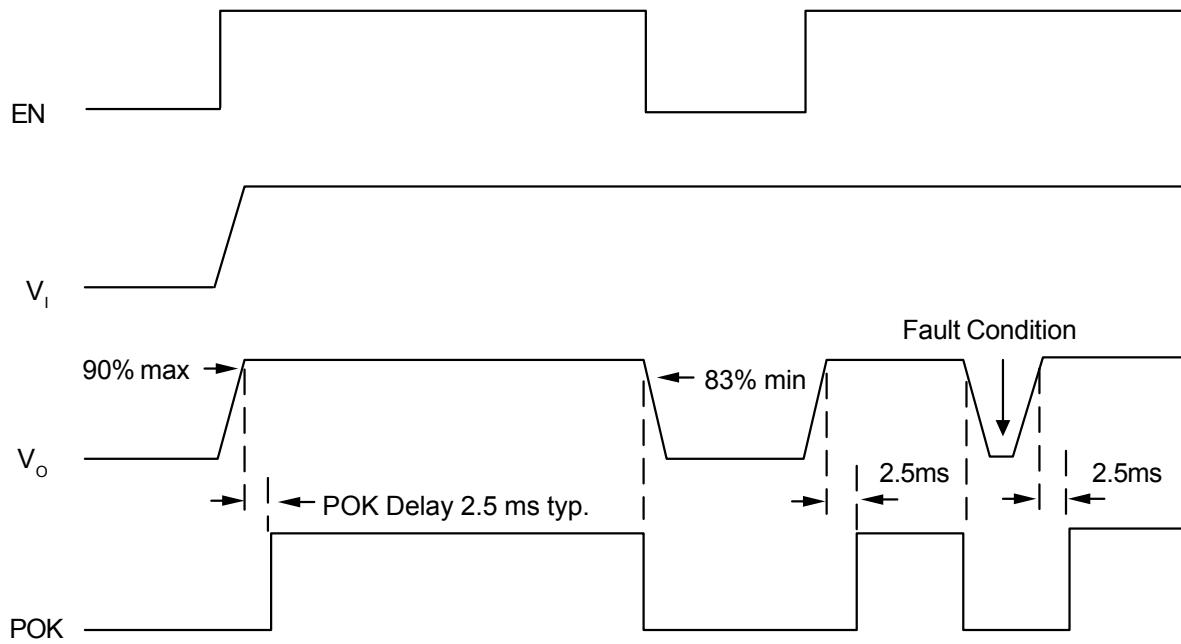

Typical Characteristics

Current Limit vs. Input Voltage

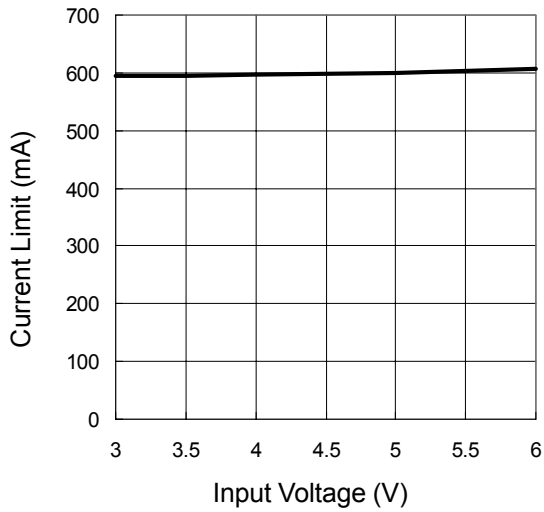

Ground Pin Current vs. Output Current

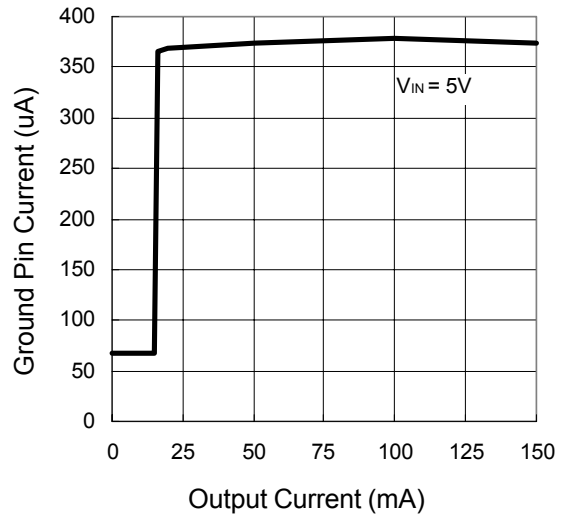

POK Delay Time vs. Input Voltage

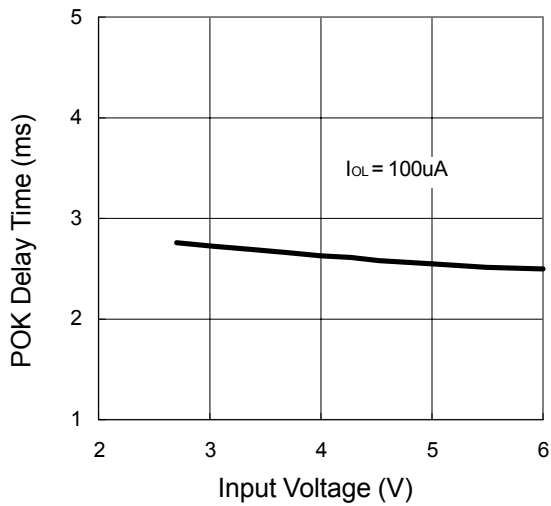

POK Sink Current vs. POK Low Voltage

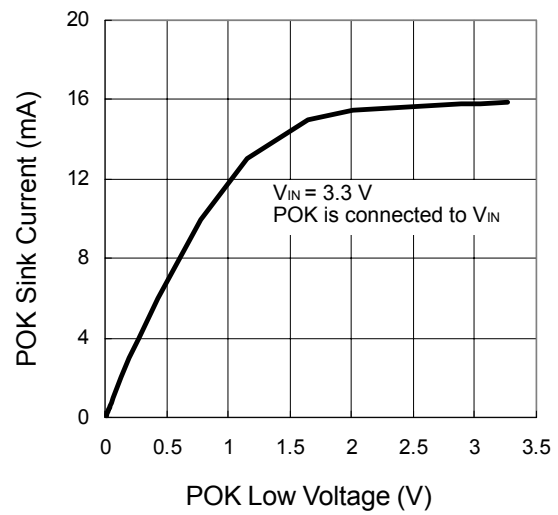

Typical Characteristics

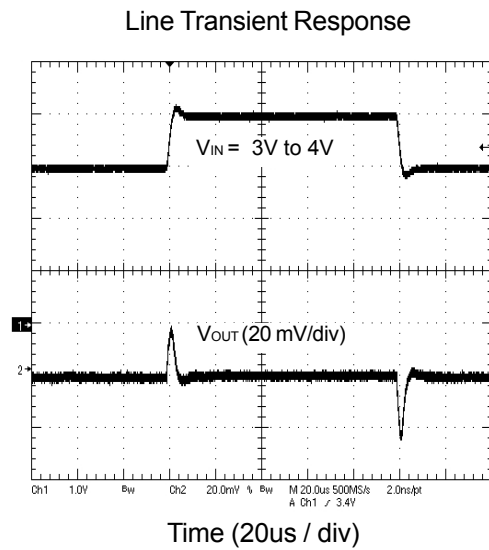
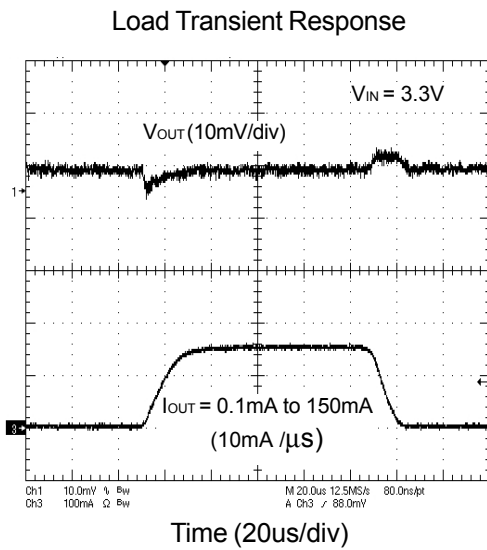
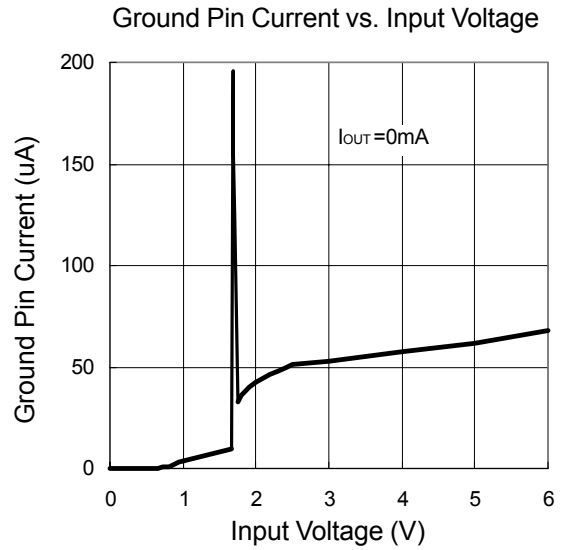
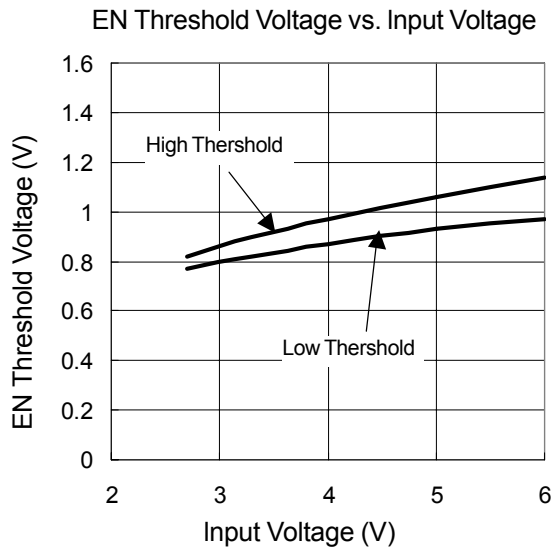

Typical Characteristics

Region of Stable C_{OUT} ESR vs. Output Current

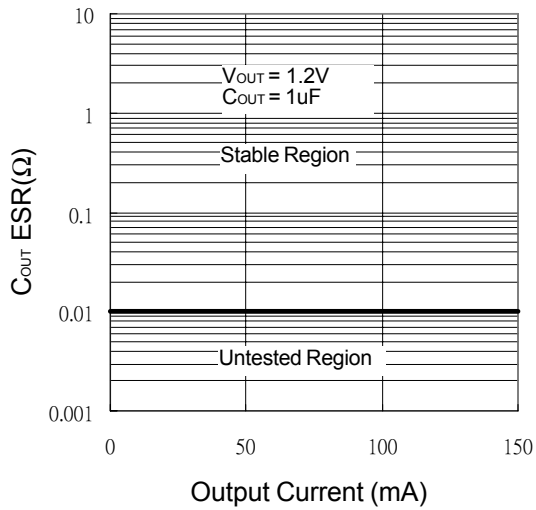

Power Up

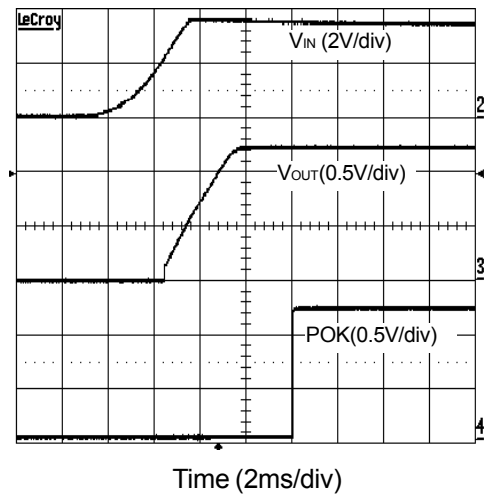

Power Down

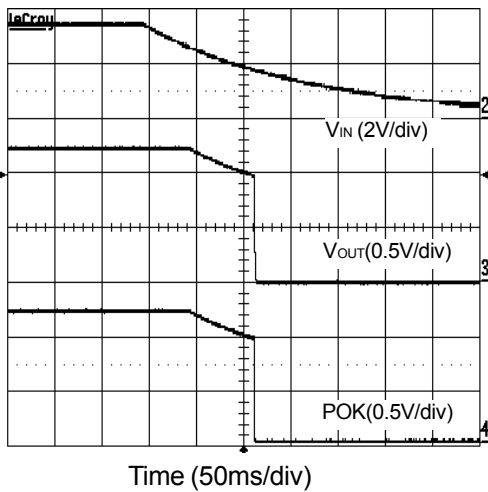

Exiting Shutdown

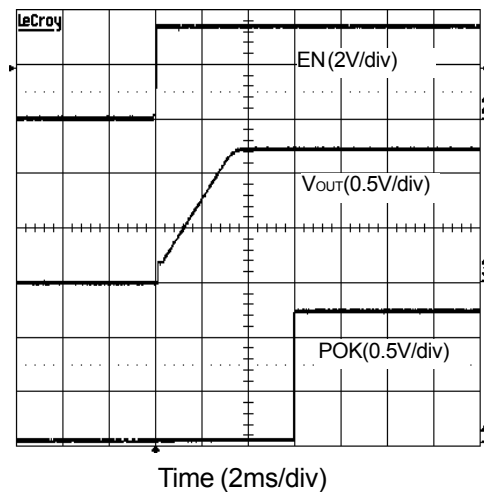

Typical Characteristics

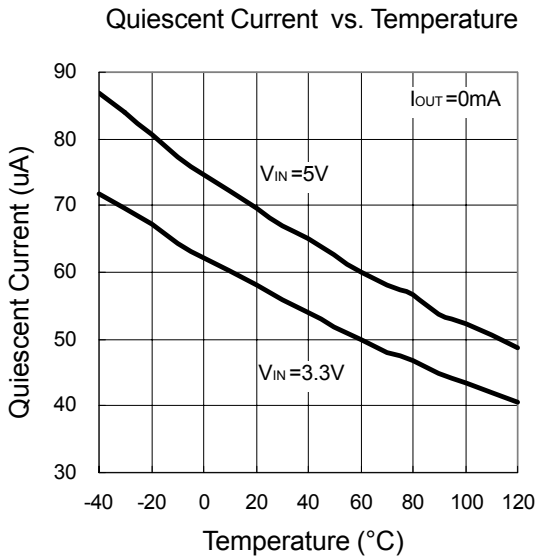
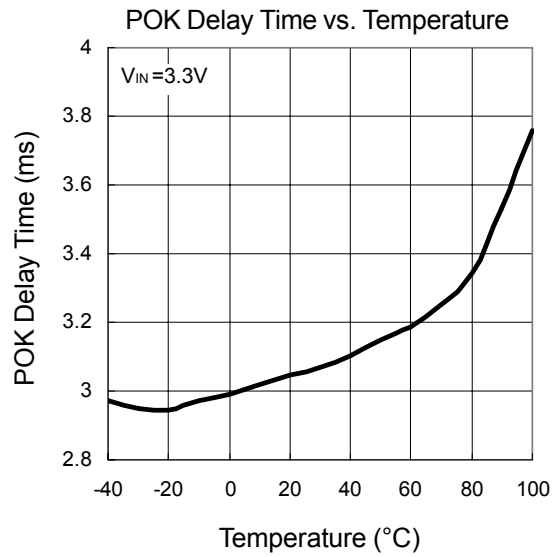
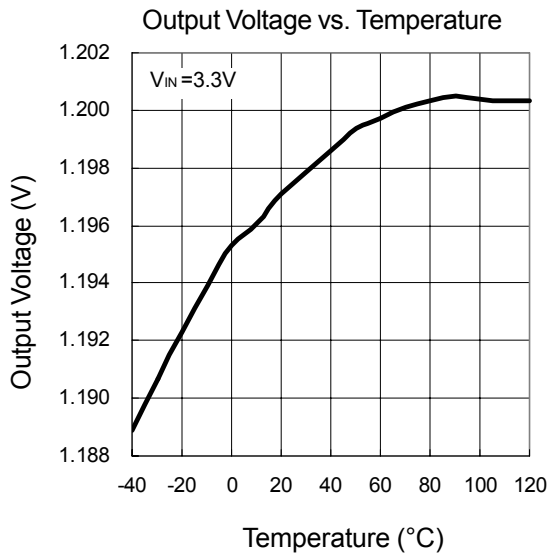

Application Information

Capacitor Selection and Regulator Stability

The APL5158 use at least a 1 μ F capacitor on the input. This capacitor can use Aluminum, Tantalum or Ceramic capacitors. Input capacitor with large value and low ESR provides better PSRR and line-transient response. The output capacitor also can use Aluminum, Tantalum or Ceramic capacitors, and it's minimum values is recommended 1 μ F, ESR must be above 0.01 Ω . The Curve of the region of stable C_{OUT} ESR vs. load current in Typical Characteristics shows the output capacitor ESR and load current range for APL5158 stability. Large output capacitor values can reduce noise and improve load-transient response, stability, and PSRR. Note that some ceramic dielectrics exhibit large capacitance and ESR variation with Temperature. If use this capacitor, it may be necessary to use 2.2 μ F or more to ensure stability at temperature below -10°C.

Load-Transient Considerations

The APL5158 Load-transient response graphs in Typical Characteristics show the transient response. A step change in the load current from 0.1mA to 150mA at 15 μ s second will cause less than 10mV transient spike. Large output capacitor's value and low ESR can reduce transient spike.

Shutdown/Enable

The APL5158 has an active high enable function. Force EN high (>1.6V) enables the regulator, EN low (<0.4V) disables the regulator and enter the shutdown mode, it also causes the output voltage to discharge through a 500 Ω resistance to ground. In shutdown mode, the quiescent current can reduce below 1 μ A. The EN pin cannot be floating, a floating EN pin may cause an indeterminate state on the output. If it is no use, connect to V_{IN} for normal operation.

Power Ok

The power ok function monitors the output voltage and drives high or low to indicate a fault. When a fault condition such as overcurrent, undervoltage, thermal shutdown, or dropout occurs, the power ok output is pulled low. The power ok output comes back when the output voltage has reached 90% of its nominal value and with a typ. 2.5ms delay time. The power ok is an open-drain output, connect a 10k Ω resistance to V_{OUT} for typical application

Input-Output (Dropout)Voltage

The minimum input-output voltage differential (dropout) determines the lowest usable supply voltage. The minimum input voltage is 2.7V and output voltage is 1.2V, so the dropout voltage is 1.5V.

Reverse Protection

The APL5158 has an internal reverse protection, it doesn't need an external schottky diode to connect the regulator input and output. If the output voltage is forced above the input voltage, the IC will be shutdown and the reverse output current is below 4mA, it will increase with the output voltage. The maximum allowable output voltage is 7V (see Absolute Maximum Ratings).

Current Limit

The APL5158 has a current limit protection, which senses the current flows the P-channel MOSFET, and controls the output voltage. The point where limiting occurs is $I_{OUT}=600$ mA and the output voltage will be shutdown. The output can be shorted to ground for an indefinite amount of time without damaging the part.

Application Information

Thermal Protection

Thermal protection limits total power dissipation in the APL5158. When the junction temperature exceeds $T_J=+150^{\circ}\text{C}$, the thermal sensor generate a logic signal to turn off the pass transistor and let IC to cool. When the IC's junction temperature cools by 15°C , the thermal sensor will turn the pass transistor on again, resulting in a pulsed output during continuous thermal protection. Thermal protection is designed to protect the IC in the event of fault conditions. For continual operation, do not exceed the absolute maximum junction temperature rating of $T_J=+150^{\circ}\text{C}$.

Operating Region and Power Dissipation

The thermal resistance of the case and circuit board, ambient and junction air temperature, and the rate of air flow all control the APL5158's maximum power dissipation. The power dissipation across the device is $P = I_{\text{OUT}}(V_{\text{IN}} - V_{\text{OUT}})$. The maximum power dissipation is:

$$P_{\text{MAX}} = (T_J - T_A) / (\theta_{\text{JB}} + \theta_{\text{BA}})$$

where $T_J - T_A$ is the temperature difference between the junction and ambient air. θ_{JB} (or θ_{JA}) is the thermal resistance of the package, θ_{BA} is the thermal resistance through the printed circuit board, copper traces, and other materials to the surrounding air.

The GND pin of the APL5158 provide an electrical connection to ground and channeling heat away. Connect the GND pin to ground using a large pad or ground plane as a heatsink, it can improve maximize thermal dissipation.

Packaging Information

SOT-23-5

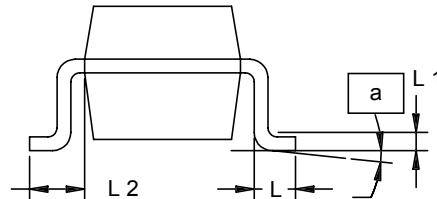
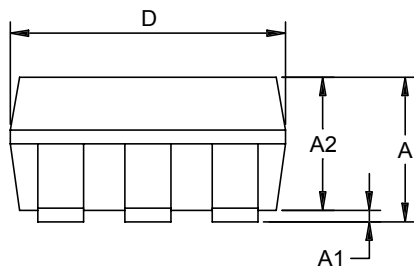
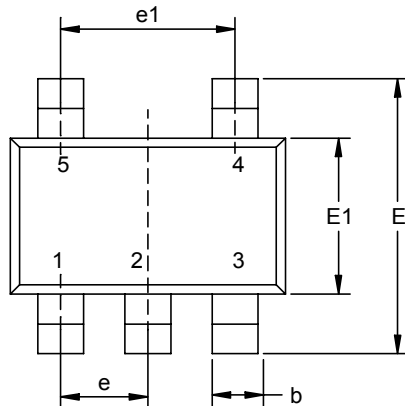

Dim	Millimeters		Inches	
	Min.	Max.	Min.	Max.
A	0.95	1.45	0.037	0.057
A1	0.05	0.15	0.002	0.006
A2	0.90	1.30	0.035	0.051
b	0.30	0.50	0.011	0.019
D	2.8	3.00	0.110	0.118
E	2.6	3.00	0.102	0.118
E1	1.5	1.70	0.059	0.067
e	0.95BSC		0.037BSC	
e1	1.90BSC		0.074BSC	
L	0.35	0.55	0.014	0.022
L1	0.20 BSC		0.008 BSC	
L2	0.5	0.7	0.020	0.028
N	5		5	
α	0°	10°	0°	10°

Physical Specifications

Terminal Material	Solder-Plated Copper (Solder Material : 90/10 or 63/37 SnPb), 100%Sn
Lead Solderability	Meets EIA Specification RS186-91, ANSI/J-STD-002 Category 3.

Reflow Condition (IR/Convection or VPR Reflow)

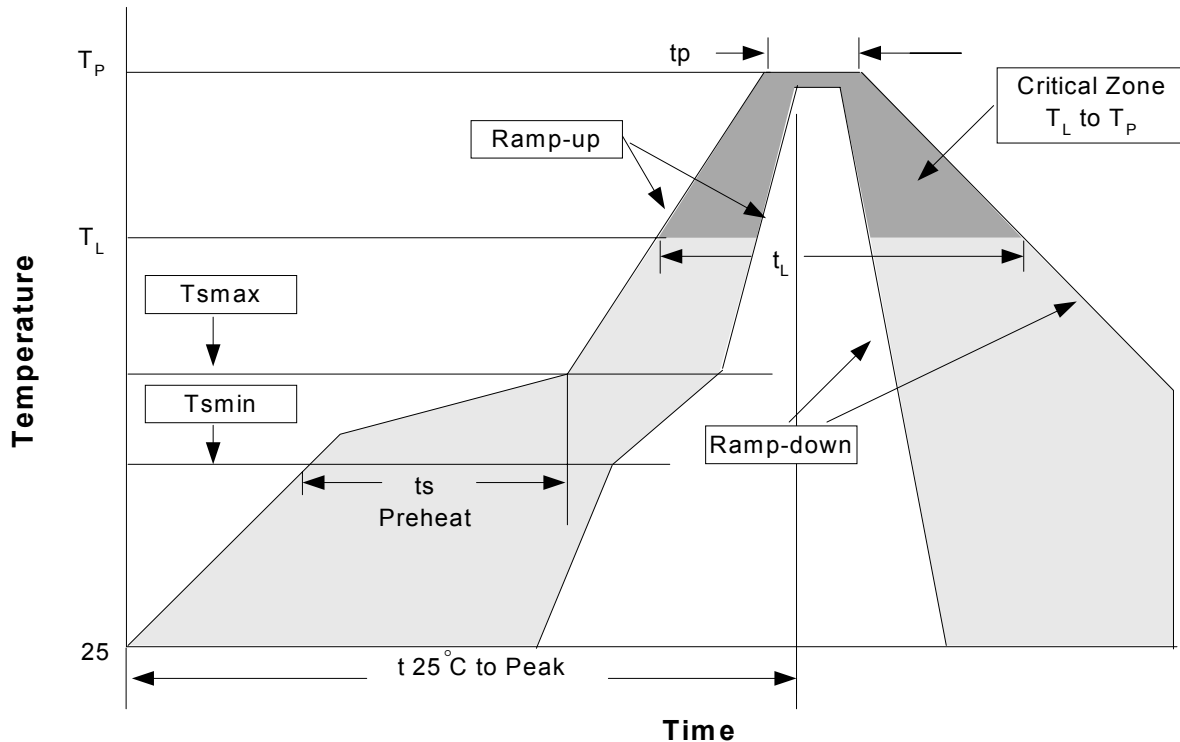

Classification Reflow Profiles

Profile Feature	Sn-Pb Eutectic Assembly		Pb-Free Assembly	
	Large Body	Small Body	Large Body	Small Body
Average ramp-up rate (T _L to T _P)	3°C/second max.		3°C/second max.	
Preheat				
- Temperature Min (T _{smin})	100°C		150°C	
- Temperature Mix (T _{smax})	150°C		200°C	
- Time (min to max)(t _s)	60-120 seconds		60-180 seconds	
T _{smax} to T _L				
- Ramp-up Rate			3°C/second max	
T _{smax} to T _L				
- Temperature(T _L)	183°C		217°C	
- Time (t _L)	60-150 seconds		60-150 seconds	
Peak Temperature(T _p)	225 +0/-5°C	240 +0/-5°C	245 +0/-5°C	250 +0/-5°C
Time within 5°C of actual Peak Temperature(t _p)	10-30 seconds	10-30 seconds	10-30 seconds	20-40 seconds
Ramp-down Rate	6°C/second max.		6°C/second max.	
Time 25°C to Peak Temperature	6 minutes max.		8 minutes max.	

Note: All temperatures refer to topside of the package. Measured on the body surface.

Reliability Test Program

Test item	Method	Description
SOLDERABILITY	MIL-STD-883D-2003	245°C, 5 SEC
HOLT	MIL-STD-883D-1005.7	1000 Hrs Bias @125°C
PCT	JESD-22-B,A102	168 Hrs, 100%RH, 121°C
TST	MIL-STD-883D-1011.9	-65°C~150°C, 200 Cycles
ESD	MIL-STD-883D-3015.7	VHBM > 2KV, VMM > 200V
Latch-Up	JESD 78	10ms, $1_{tr} > 100mA$

Carrier Tape

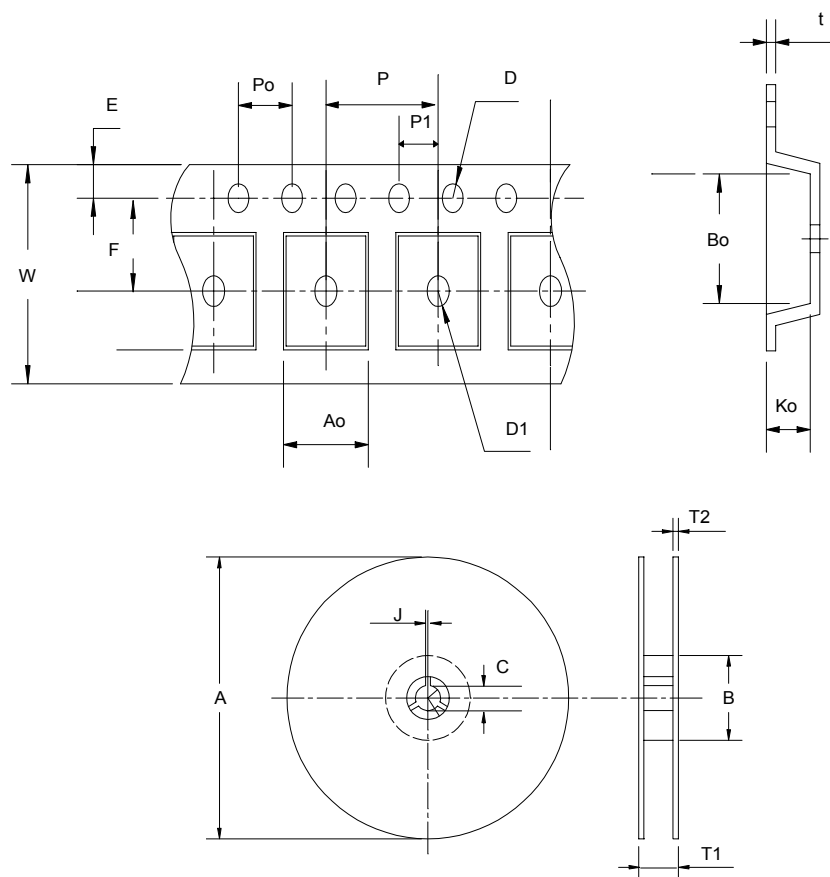

Application	A	B	C	J	T1	T2	W	P	E
SOT-23-5	178±1	72 ± 1.0	13.0 + 0.2	2.5 ± 0.15	8.4 ± 2	1.5± 0.3	8.0 ^{+0.3} _{-0.3}	4 ± 0.1	1.75± 0.1
	F	D	D1	P ₀	P1	A ₀	B ₀	K ₀	t
	3.5 ± 0.05	1.5 + 0.1	1.5 + 0.1	4.0 ± 0.1	2.0 ± 0.1	3.15 ± 0.1	3.2± 0.1	1.4± 0.1	0.2±0.03

(mm)

Cover Tape Dimensions

Application	Carrier Width	Cover Tape Width	Devices Per Reel
SOT- 23	8	5.3	3000

Customer Service

Anpec Electronics Corp.

Head Office :

5F, No. 2 Li-Hsin Road, SBIP,
Hsin-Chu, Taiwan, R.O.C.

Tel : 886-3-5642000

Fax : 886-3-5642050

Taipei Branch :

7F, No. 137, Lane 235, Pac Chiao Rd.,
Hsin Tien City, Taipei Hsien, Taiwan, R. O. C.

Tel : 886-2-89191368

Fax : 886-2-89191369