

3A Low Dropout Fast Response Positive Adjustable Regulator and Fixed 3.3V

Features

- **Fast Transient Response**
- **Guaranteed Dropout Voltage at Multiple Currents**
- **Load Regulation : 0.05% Typ.**
- **Line Regulation : 0.03% Typ.**
- **Low Dropout Voltage : 1.2V Typ. at $I_{OUT} = 3A$**
- **Trimmed Current Limit : 3A Typ. at $T_J = 125^\circ C$**
- **On-Chip Thermal Limiting : 150°C Typ.**
- **Standard 3-Pin TO-220, TO-252, and TO-263 Power Package**
- **Lead Free and Green Devices Available (RoHS Compliant)**

Applications

- **Pentium™ Processor Supplies**
- **Power PC™ Supplies**
- **Low Voltage Logic Supplies**
- **Battery-Powered Circuitry**
- **Post Regulator for Switching Power Supply**

General Description

The APL1085 is a low dropout three-terminal adjustable regulator with 3A output current capability. In order to obtain lower dropout voltage and faster transient response which is critical for low voltage applications, the APL1085 has been optimized. The output available voltage range of adjustable version is from 1.25 to 5.75V with an input supply below 7V, and the fixed 3.3V output voltage device is also available.

Current limit is trimmed to ensure specified output current and controlled short-circuit current. On-chip thermal limiting provides protection against any combination of overload that would create excessive junction temperatures.

The APL1085 is available in both the through-hole and surface mount versions of the industry standard 3-pin TO-220, TO-252, and TO-263 power packages.

Pin Configuration

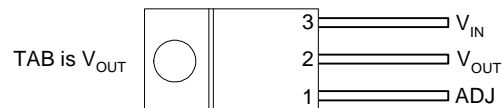

Front View APL1085 TO-220 Package

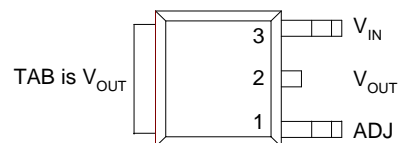

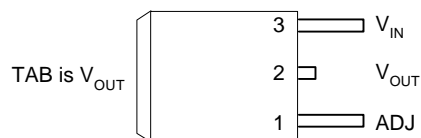

Front View APL1085 TO-252 Package



Front View APL1085 TO-263 Package

ANPEC reserves the right to make changes to improve reliability or manufacturability without notice, and advise customers to obtain the latest version of relevant information to verify before placing orders.

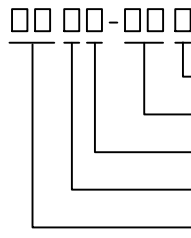
Ordering and Marking Information

APL1085	 <p>Assembly Material Handling Code Temperature Range Package Code Voltage Code</p>	<p>Package Code G : TO-263-3 U : TO-252-3 F : TO-220-3</p> <p>Temperature Range C : 0 to 70 °C</p> <p>Handling Code TR : Tape & Reel TU : Tube</p> <p>Voltage Code : 33 : 3.3V Blank : Adjustable Version</p> <p>Assembly Material L : Lead Free Device G : Halogen and Lead Free Device</p>
APL1085 U :		XXXXX - Date Code
APL1085-33 G :		XXXXX - Date Code

Note: ANPEC lead-free products contain molding compounds/die attach materials and 100% matte tin plate termination finish; which are fully compliant with RoHS. ANPEC lead-free products meet or exceed the lead-free requirements of IPC/JEDEC J-STD-020C for MSL classification at lead-free peak reflow temperature. ANPEC defines “Green” to mean lead-free (RoHS compliant) and halogen free (Br or Cl does not exceed 900ppm by weight in homogeneous material and total of Br and Cl does not exceed 1500ppm by weight).

Absolute Maximum Ratings (Note 1, 2)

Symbol	Parameter	Rating	Unit
V_I	Input Voltage	7	V
P_D	Power Dissipation	Internally Limited	W
T_J	Junction Temperature	150	°C
T_{STG}	Storage Temperature Range	-65 to +150	°C
T_L	Maximum Lead Soldering Temperature, 10 Seconds	260	°C

Note 1: Absolute Maximum Ratings are those values beyond which the life of a device may be impaired. Exposure to absolute maximum rating conditions for extended periods may affect device reliability.

Note 2: The maximum allowable power dissipation at any T_A (ambient temperature) is calculated using: $P_D (max) = (T_J - T_A) / \theta_{JA}$; $T_J = 125^\circ\text{C}$. Exceeding the maximum allowable power dissipation will result in excessive die temperature.

Electrical Characteristics

Symbol	Parameter	Test Conditions	APL1085			Unit
			Min.	Typ.	Max.	
V_{REF}	Reference Voltage	$1.5V \leq (V_{IN} - V_{OUT}) \leq 5.75V$, $10mA \leq I_{OUT} \leq 3A$, $T_J = 0 \sim 125^\circ\text{C}$	1.225 (-2%)	1.250	1.275 (+2%)	V
V_{OUT}	Output Voltage APL1085-33	$10mA \leq I_{OUT} \leq 3A$, $4.75V \leq V_{IN} \leq 7V$, $T_J = 0 \sim 125^\circ\text{C}$	3.235 (-2%)	3.300	3.365 (+2%)	V
REG_{LINE}	Line Regulation APL1085 APL1085-33	$T_J = 0 \sim 125^\circ\text{C}$, (Note 3) $2.75V \leq V_{IN} \leq 7V$, $I_{OUT} = 10mA$, $4.75V \leq V_{IN} \leq 7V$, $I_{OUT} = 0mA$	-	0.03	0.2	%
REG_{LOAD}	Load Regulation APL1085 APL1085-33	$T_J = 25^\circ\text{C}$, (Note 3) $(V_{IN} - V_{OUT}) = 3V$, $10mA \leq I_{OUT} \leq 3A$ $V_{IN} = 5V$, $0mA \leq I_{OUT} \leq 3A$	-	0.05 0.05	0.3 0.5	%

Electrical Characteristics (Cont.)

Symbol	Parameter	Test Conditions	APL1085			Unit
			Min.	Typ.	Max.	
V_D	Dropout Voltage	$\Delta V_{REF}=1\%$, $I_{OUT}=3A$, $T_J=0\sim 125^\circ C$	-	1.3	1.4	V
I_{LIMIT}	Current Limit	$(V_{IN}-V_{OUT})=1.7V$, $T_J=25^\circ C$ $T_J=125^\circ C$	4.5 3.5	6.0 5.0	-	A
		$(V_{IN}-V_{OUT})=3V$, $T_J=25^\circ C$ $T_J=125^\circ C$	5.0 4.0	6.5 5.5	-	
I_{ADJ}	Adjust Pin Current	$(V_{IN}-V_{OUT})=3V$, $I_{OUT}=10mA$, $T_J=0\sim 125^\circ C$	-	60	120	μA
ΔI_{ADJ}	Adjust Pin Current Change APL1085	$1.5V \leq (V_{IN}-V_{OUT}) \leq 5.75V$, $10mA \leq I_{OUT} \leq 3A$	-	0.2	5	μA
I_{LMIN}	Minimum Load Current APL1085	$1.5V \leq (V_{IN}-V_{OUT}) \leq 5.75V$, $T_J=0\sim 125^\circ C$	-	2	10	mA
I_Q	Quiescent Current APL1085-33	$V_{IN}=5V$	-	8	13	mA
PSRR	Ripple Rejection	$F=120Hz$, $C_{OUT}=22\mu F$, T_{ant} , $(V_{IN}-V_{OUT})=3V$, $I_{OUT}=3A$	60	-	-	dB
L_S	Long -Term Stability	$T_J=125^\circ C$, 1000Hrs.	-	0.03	1.0	%
V_N	RMS Output Noise (% of V_{OUT})	$T_J=25^\circ C$, $10Hz \leq F \leq 10kHz$	-	0.003	-	%
θ_{JC}	Thermal Resistance Junction to Case		-	-	3.0	$^\circ C/W$

Note 3 : See thermal regulation specifications for changes in output voltage due to heating effects. Load and line regulations are measured at a constant junction temperature by low duty cycle pulse testing.

Typical Application Circuit

Typical Regulator

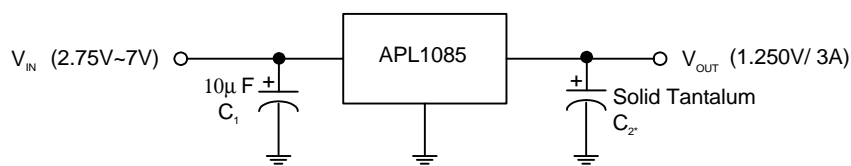

5V to 3.3V Regulator

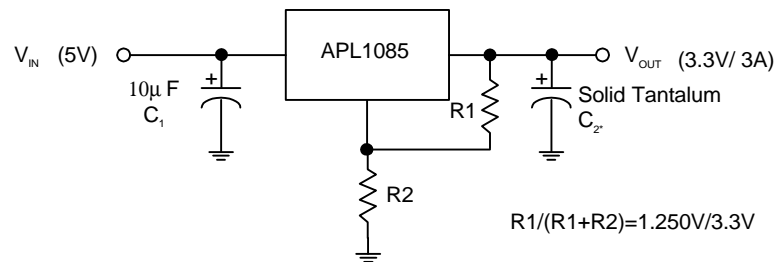

*Required for stability

APL1085: $C_2=10\mu F$

* R1 is typically in range of 100 Ω to 120 Ω

Typical Operating Characteristics

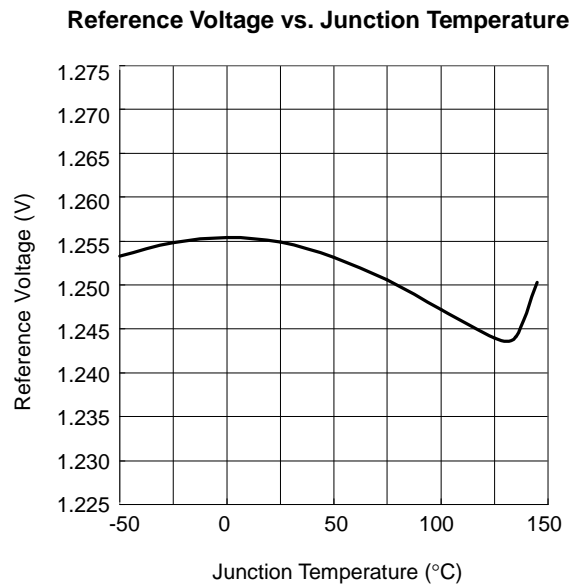
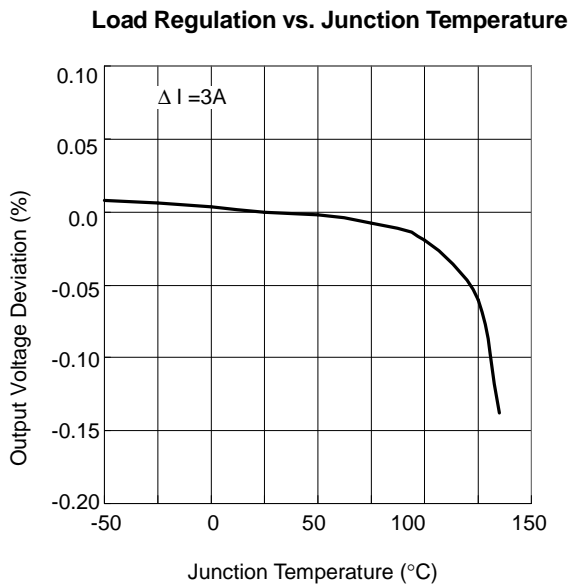
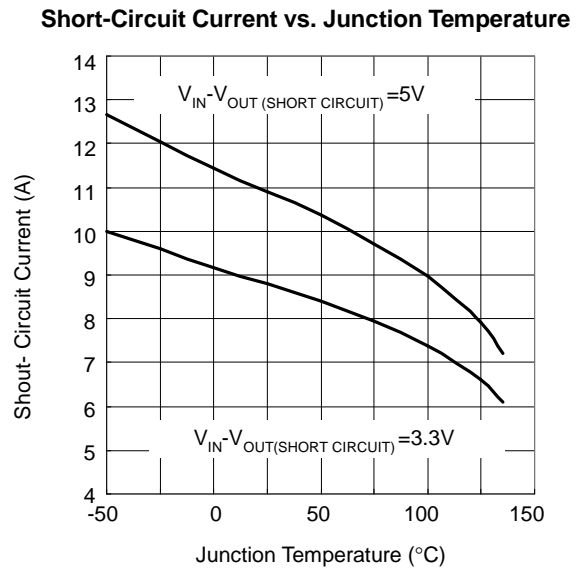
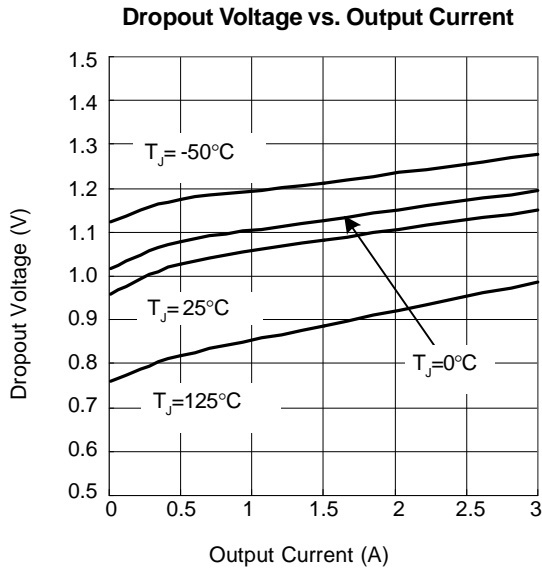

Typical Operating Characteristics (Cont.)

Minimum Load Current vs. Junction Temperature

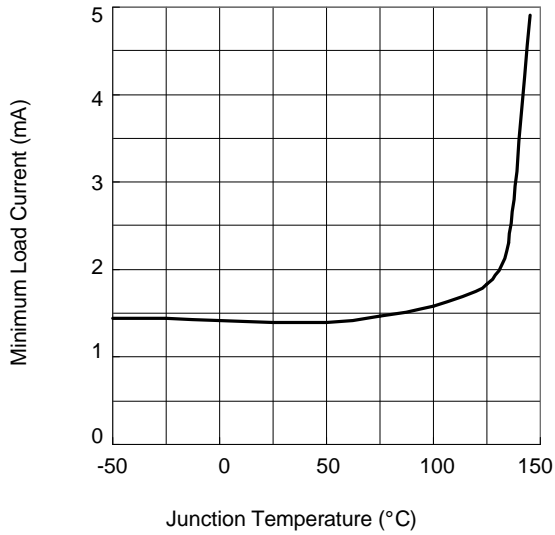

Adjust Pin Current vs. Junction Temperature

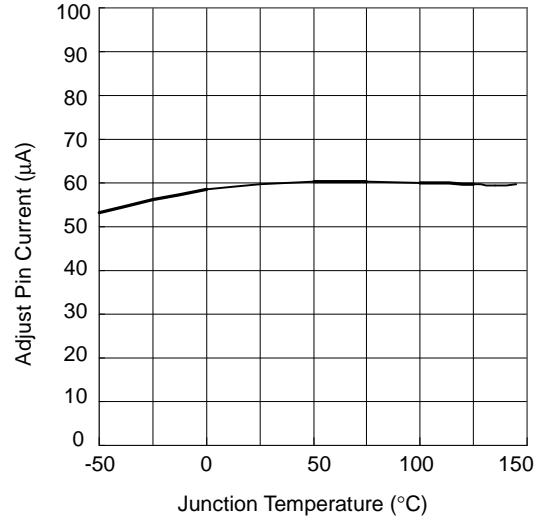

Ripple Rejection vs. Frequency

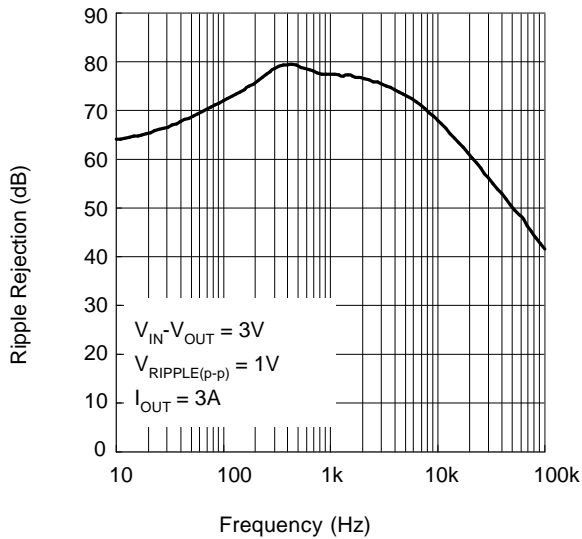

Maximum Power Dissipation*

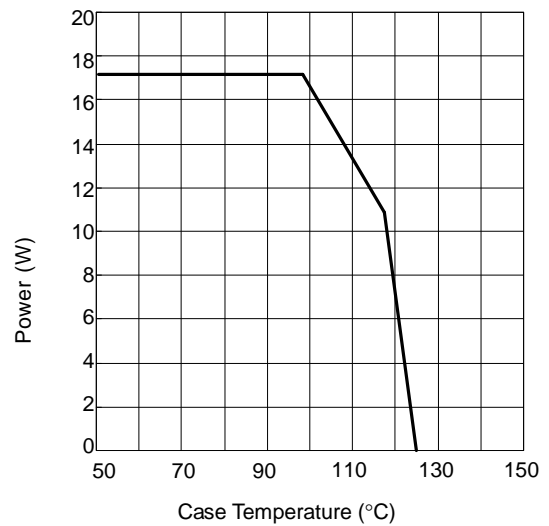

* as Limited by Maximum Jcnction Temperature

Package Information

TO-263-3

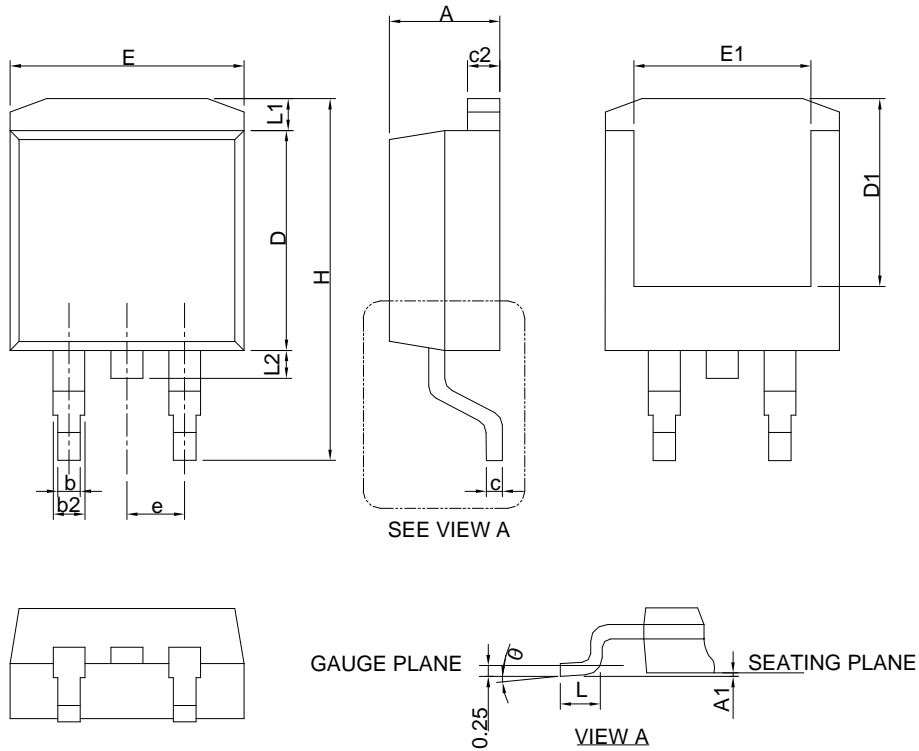

DIMENSIONS	TO-263-3			
	MILLIMETERS		INCHES	
	MIN.	MAX.	MIN.	MAX.
A	4.06	4.83	0.160	0.190
A1	0.00	0.25	0.000	0.010
b	0.51	0.99	0.020	0.039
b2	1.14	1.78	0.045	0.070
c	0.38	0.74	0.015	0.029
c2	1.14	1.65	0.045	0.065
D	8.38	9.65	0.330	0.380
D1	6.00	9.00	0.236	0.354
E	9.65	11.43	0.380	0.450
E1	6.22	9.00	0.245	0.354
e	2.54 BSC		0.100 BSC	
H	14.61	15.88	0.575	0.625
L	1.78	2.79	0.070	0.110
L1		1.68		0.066
L2		1.78		0.070
θ	0°	8°	0°	8°

Note : Follow JEDEC TO-263 AB.

Package Information

TO-252-3

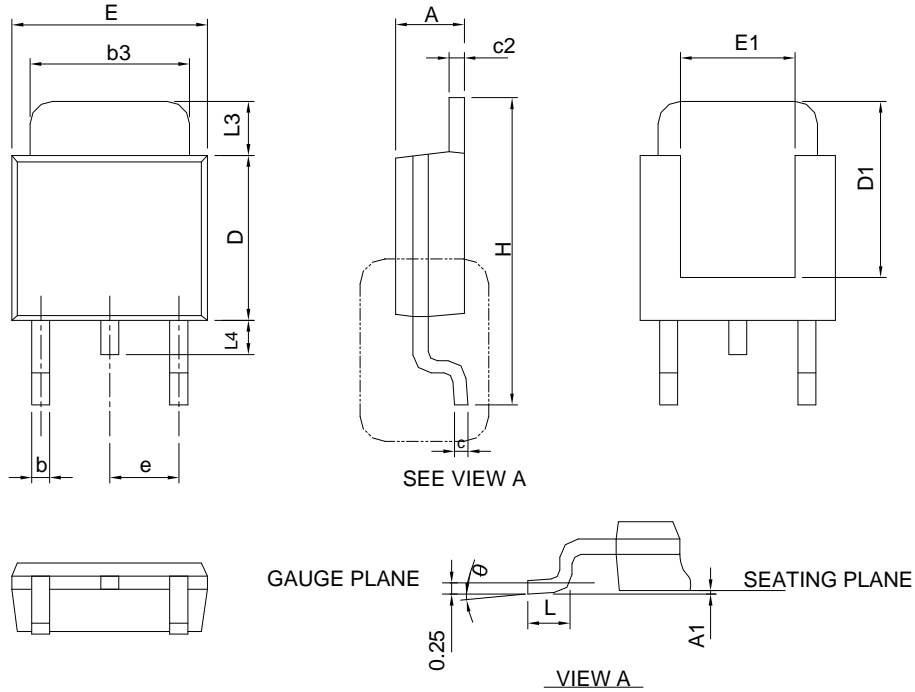

DIMENSIONS	TO-252-3			
	MILLIMETERS		INCHES	
	MIN.	MAX.	MIN.	MAX.
A	2.18	2.39	0.086	0.094
A1		0.13		0.005
b	0.50	0.89	0.020	0.035
b3	4.95	5.46	0.195	0.215
c	0.46	0.61	0.018	0.024
c2	0.46	0.89	0.018	0.035
D	5.33	6.22	0.210	0.245
D1	4.57	6.00	0.180	0.236
E	6.35	6.73	0.250	0.265
E1	3.81	6.00	0.150	0.236
e	2.29 BSC		0.090 BSC	
H	9.40	10.41	0.370	0.410
L	0.90	1.78	0.035	0.070
L3	0.89	2.03	0.035	0.080
L4		1.02		0.040
θ	0°	8°	0°	8°

Note : Follow JEDEC TO-252 .

Carrier Tape & Reel Dimensions

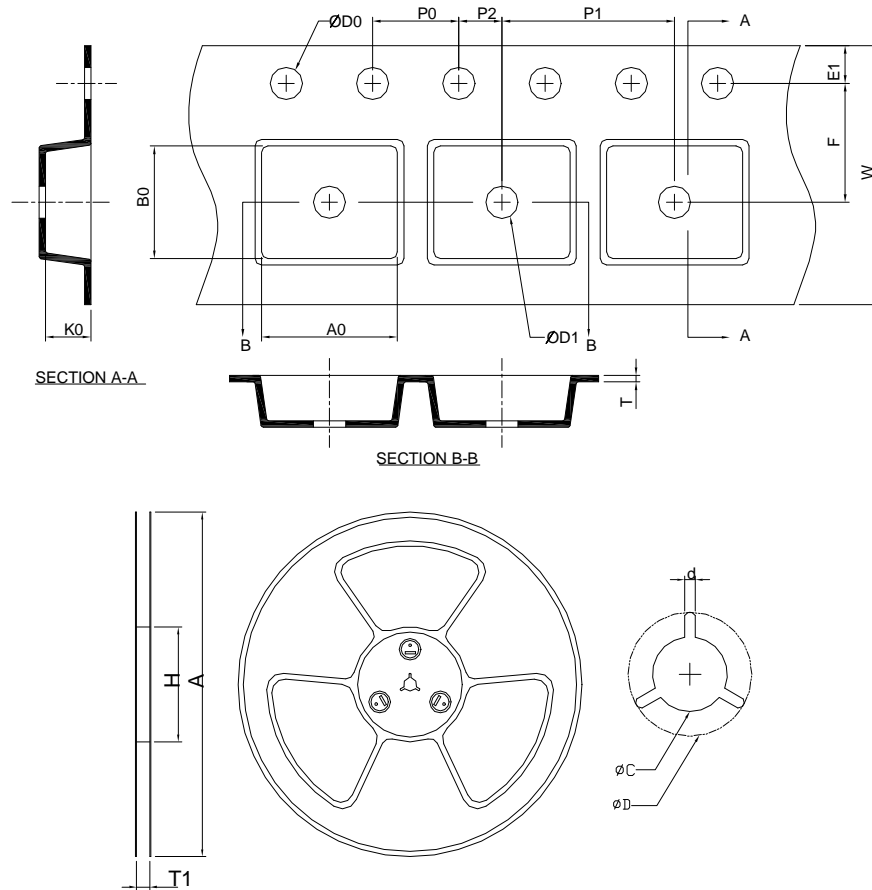

Application	A	H	T1	C	d	D	W	E1	F
TO-252-3	330.0 ±0.00	50 MIN.	16.4+2.00 -0.00	13.0+0.50 -0.20	1.5 MIN.	20.2 MIN.	16.0 ±0.30	1.75 ±0.10	7.50 ±0.05
	P0	P1	P2	D0	D1	T	A0	B0	K0
	4.0 ±0.10	8.0 ±0.10	2.0 ±0.05	1.5+0.10 -0.00	1.5 MIN.	0.6+0.00 -0.40	6.80 ±0.20	10.40 ±0.20	2.50 ±0.20
Application	A	H	T1	C	d	D	W	E1	F
TO-263-3	330.0 ±0.00	50 MIN.	24.4+2.00 -0.00	13.0+0.50 -0.20	1.5 MIN.	20.2 MIN.	24.0 ±0.30	1.75 ±0.10	11.5 ±0.10
	P0	P1	P2	D0	D1	T	A0	B0	K0
	4.0 ±0.10	16.0 ±0.10	2.0 ±0.10	1.5+0.10 -0.00	1.5 MIN.	0.6+0.00 -0.40	10.8 ±0.20	16.1 ±0.20	5.2 ±0.20

(mm)

Devices Per Unit

Package Type	Unit	Quantity
TO-252-3	Tape & Reel	2500
TO-263-3	Tape & Reel	800

Taping Direction Information

TO-263-3

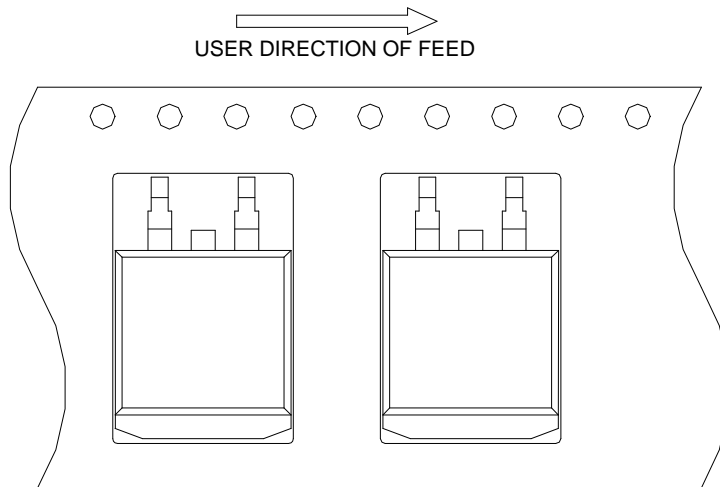

TO-252-3

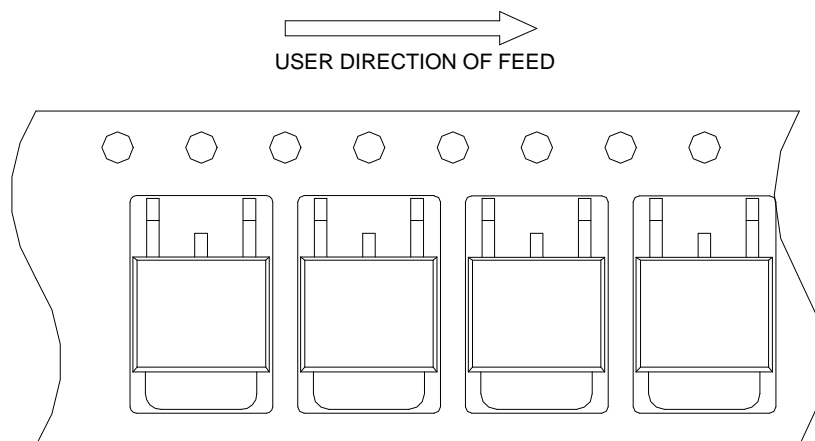

Classification Profile

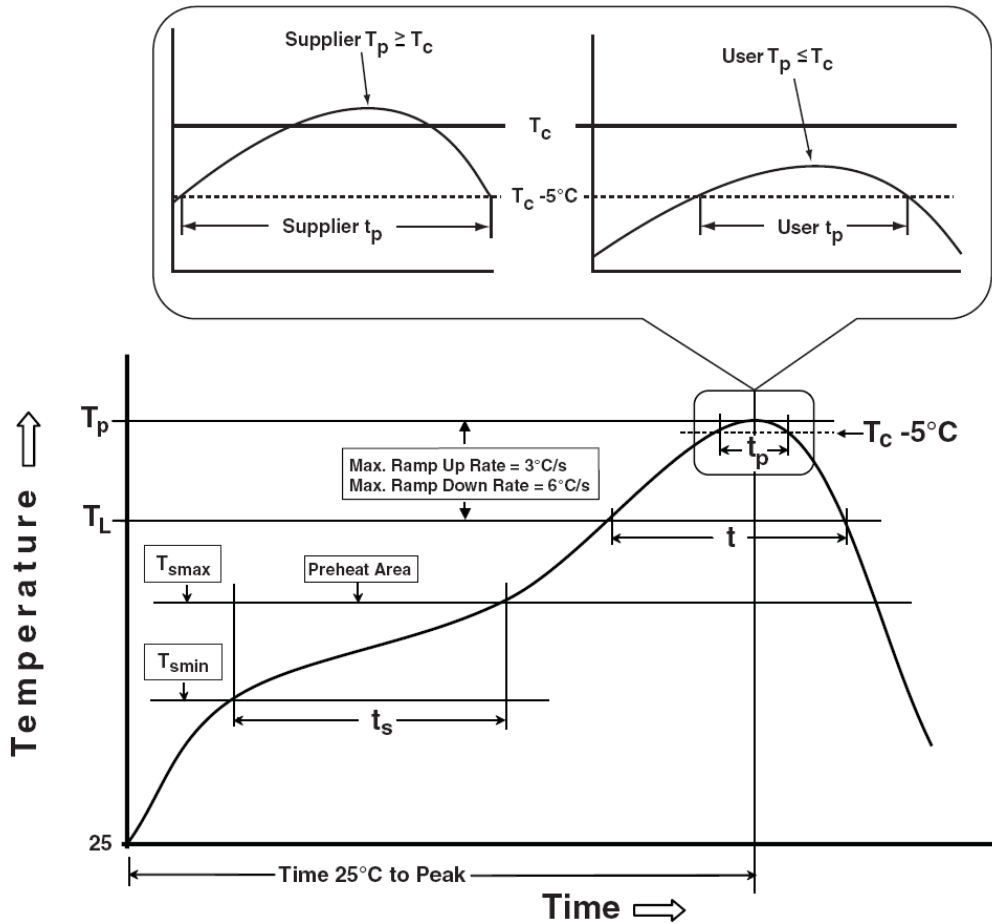

Classification Reflow Profiles

Profile Feature	Sn-Pb Eutectic Assembly	Pb-Free Assembly
Preheat & Soak		
Temperature min (T_{smin})	100 °C	150 °C
Temperature max (T_{smax})	150 °C	200 °C
Time (T_{smin} to T_{smax}) (t_s)	60-120 seconds	60-120 seconds
Average ramp-up rate (T_{smax} to T_p)	3 °C/second max.	3°C/second max.
Liquidous temperature (T_L)	183 °C	217 °C
Time at liquidous (t_L)	60-150 seconds	60-150 seconds
Peak package body Temperature (T_p)*	See Classification Temp in table 1	See Classification Temp in table 2
Time (t_p)** within 5°C of the specified classification temperature (T_c)	20** seconds	30** seconds
Average ramp-down rate (T_p to T_{smax})	6 °C/second max.	6 °C/second max.
Time 25°C to peak temperature	6 minutes max.	8 minutes max.

* Tolerance for peak profile Temperature (T_p) is defined as a supplier minimum and a user maximum.
 ** Tolerance for time at peak profile temperature (t_p) is defined as a supplier minimum and a user maximum.

Classification Reflow Profiles (Cont.)

Table 1. SnPb Eutectic Process – Classification Temperatures (Tc)

Package Thickness	Volume mm ³ <350	Volume mm ³ ≥350
<2.5 mm	235 °C	220 °C
≥2.5 mm	220 °C	220 °C

Table 2. Pb-free Process – Classification Temperatures (Tc)

Package Thickness	Volume mm ³ <350	Volume mm ³ 350-2000	Volume mm ³ >2000
<1.6 mm	260 °C	260 °C	260 °C
1.6 mm – 2.5 mm	260 °C	250 °C	245 °C
≥2.5 mm	250 °C	245 °C	245 °C

Reliability Test Program

Test item	Method	Description
SOLDERABILITY	JESD-22, B102	5 Sec, 245°C
HOLT	JESD-22, A108	1000 Hrs, Bias @ 125°C
PCT	JESD-22, A102	168 Hrs, 100%RH, 2atm, 121°C
TCT	JESD-22, A104	500 Cycles, -65°C~150°C
ESD	MIL-STD-883-3015.7	VHBM 2KV, VMM 200V
Latch-Up	JESD 78	10ms, 1 _{tr} 100mA

Customer Service

Anpec Electronics Corp.

Head Office :

No.6, Dusing 1st Road, SBIP,
Hsin-Chu, Taiwan, R.O.C.
Tel : 886-3-5642000
Fax : 886-3-5642050

Taipei Branch :

2F, No. 11, Lane 218, Sec 2 Jhongsing Rd.,
Sindian City, Taipei County 23146, Taiwan
Tel : 886-2-2910-3838
Fax : 886-2-2917-3838